

Enterasys® SecureStack™ B2

Gigabit and Fast Ethernet Switches

Hardware Installation Guide

B2G124-24

B2G124-48

B2H124-48



Electrical Hazard: Only qualified personnel should perform installation procedures.

Riesgo Electrico: Solamente personal calificado debe realizar procedimientos de instalacion.

Elektrischer Gefahrenhinweis: Installationen sollten nur durch ausgebildetes und qualifiziertes Personal vorgenommen werden.

Notice

Enterasys Networks reserves the right to make changes in specifications and other information contained in this document and its web site without prior notice. The reader should in all cases consult Enterasys Networks to determine whether any such changes have been made.

The hardware, firmware, or software described in this document is subject to change without notice.

IN NO EVENT SHALL ENTERASYS NETWORKS BE LIABLE FOR ANY INCIDENTAL, INDIRECT, SPECIAL, OR CONSEQUENTIAL DAMAGES WHATSOEVER (INCLUDING BUT NOT LIMITED TO LOST PROFITS) ARISING OUT OF OR RELATED TO THIS DOCUMENT, WEB SITE, OR THE INFORMATION CONTAINED IN THEM, EVEN IF ENTERASYS NETWORKS HAS BEEN ADVISED OF, KNEW OF, OR SHOULD HAVE KNOWN OF, THE POSSIBILITY OF SUCH DAMAGES.

Enterasys Networks, Inc.
50 Minuteman Road
Andover, MA 01810

© 2008 Enterasys Networks, Inc. All rights reserved.

Part Number: 9034099-05 February 2008

ENTERASYS, ENTERASYS NETWORKS, ENTERASYS MATRIX, ENTERASYS SECURESTACK, LANVIEW, NETSIGHT, WEBVIEW, and any logos associated therewith, are trademarks or registered trademarks of Enterasys Networks, Inc., in the United States and other countries.

All other product names mentioned in this manual may be trademarks or registered trademarks of their respective companies.

Documentation URL: <http://www.enterasys.com/support/manuals>

Documentacion URL: <http://www.enterasys.com/support/manuals>

Dokumentation im Internet: <http://www.enterasys.com/support/manuals>

REGULATORY COMPLIANCE INFORMATION

FEDERAL COMMUNICATIONS COMMISSION (FCC) NOTICE

This device complies with Part 15 of the FCC rules. Operation is subject to the following two conditions: (1) this device may not cause harmful interference, and (2) this device must accept any interference received, including interference that may cause undesired operation.

NOTE: This equipment has been tested and found to comply with the limits for a class A digital device, pursuant to Part 15 of the FCC rules. These limits are designed to provide reasonable protection against harmful interference when the equipment is operated in a commercial environment. This equipment uses, generates, and can radiate radio frequency energy and if not installed in accordance with the operator's manual, may cause harmful interference to radio communications. Operation of this equipment in a residential area is likely to cause interference in which case the user will be required to correct the interference at his own expense.

WARNING: Changes or modifications made to this device which are not expressly approved by the party responsible for compliance could void the user's authority to operate the equipment.

INDUSTRY CANADA NOTICE

This digital apparatus does not exceed the class A limits for radio noise emissions from digital apparatus set out in the Radio Interference Regulations of the Canadian Department of Communications.

Le présent appareil numérique n'émet pas de bruits radioélectriques dépassant les limites applicables aux appareils numériques de la class A prescrites dans le Règlement sur le brouillage radioélectrique édicté par le ministère des Communications du Canada.

CLASS A ITE NOTICE

WARNING: This is a Class A product. In a domestic environment this product may cause radio interference in which case the user may be required to take adequate measures.

CLASE A. AVISO DE ITE

ADVERTENCIA: Este es un producto de Clase A. En un ambiente doméstico este producto puede causar interferencia de radio en cuyo caso puede ser requerido tomar medidas adecuadas.

KLASSE A ITE ANMERKUNG

WARNHINWEIS: Dieses Produkt zählt zur Klasse A (Industriebereich). In Wohnbereichen kann es hierdurch zu Funkstörungen kommen, daher sollten angemessene Vorkehrungen zum Schutz getroffen werden.

PRODUCT SAFETY

This product complies with the following: UL 60950, CSA C22.2 No. 60950, 73/23/EEC, EN 60950, IEC 60950, EN 60825, 21 CFR 1040.10.

SEGURIDAD DEL PRODUCTO

El producto de Enterasys cumple con lo siguiente: UL 60950, CSA C22.2 No. 60950, 73/23/EEC, EN 60950, IEC 60950, EN 60825, 21 CFR 1040.10.

PRODUKTSICHERHEIT

Dieses Produkt entspricht den folgenden Richtlinien: UL 60950, CSA C22.2 No. 60950, 73/23/EEC, EN 60950, IEC 60950, EN 60825, 21 CFR 1040.10.

ELECTROMAGNETIC COMPATIBILITY (EMC)

This product complies with the following: 47 CFR Parts 2 and 15, CSA C108.8, 89/336/EEC, EN 55022, EN 61000-3-2, EN 61000-3-3, EN 55024, AS/NZS CISPR 22, VCCI V-3.

COMPATIBILIDAD ELECTROMÁGNÉTICA (EMC)

Este producto de Enterasys cumple con lo siguiente: 47 CFR Partes 2 y 15, CSA C108.8, 89/336/EEC, EN 55022, EN 55024, EN 61000-3-2, EN 61000-3-3, AS/NZS CISPR 22, VCCI V-3.

ELEKTRO- MAGNETISCHE KOMPATIBILITÄT (EMC)

Dieses Produkt entspricht den folgenden Richtlinien: 47 CFR Parts 2 and 15, CSA C108.8, 89/336/EEC, EN 55022, EN 61000-3-2, EN 61000-3-3, EN 55024, AS/NZS CISPR 22, VCCI V-3.

HAZARDOUS SUBSTANCES

This product complies with the requirements of European Directive, 2002/95/EC, Restriction of Hazardous Substances (RoHS) in Electrical and Electronic Equipment.

EUROPEAN WASTE ELECTRICAL AND ELECTRONIC EQUIPMENT (WEEE) NOTICE

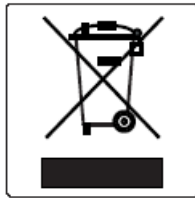

In accordance with Directive 2002/96/EC of the European Parliament on waste electrical and electronic equipment (WEEE):

1. The symbol above indicates that separate collection of electrical and electronic equipment is required and that this product was placed on the European market after August 13, 2005, the date of enforcement for Directive 2002/96/EC.
2. When this product has reached the end of its serviceable life, it cannot be disposed of as unsorted municipal waste. It must be collected and treated separately.
3. It has been determined by the European Parliament that there are potential negative effects on the environment and human health as a result of the presence of hazardous substances in electrical and electronic equipment.
4. It is the users' responsibility to utilize the available collection system to ensure WEEE is properly treated.

For information about the available collection system, please go to <http://www.enterasys.com/services/support/> or contact Enterasys Customer Support at 353 61 705586 (Ireland).

产品说明书附件

Supplement to Product Instructions

部件名称 (Parts)	有毒有害物质或元素 (Hazardous Substance)					
	铅 (Pb)	汞 (Hg)	镉 (Cd)	六价铬 (Cr ⁶⁺)	多溴联苯 (PBB)	多溴二苯醚 (PBDE)
金属部件 (Metal Parts)	×	○	○	○	○	○
电路模块 (Circuit Modules)	×	○	○	○	○	○
电缆及电缆组件 (Cables & Cable Assemblies)	×	○	○	○	○	○
塑料和聚合物部件 (Plastic and Polymeric parts)	○	○	○	○	○	○
电路开关 (Circuit Breakers)	○	○	○	○	○	○

○： 表示该有毒有害物质在该部件所有均质材料中的含量均在 SJ/T 11363-2006 标准规定的限量要求以下。
Indicates that the concentration of the hazardous substance in all homogeneous materials in the parts is below the relevant threshold of the SJ/T 11363-2006 standard.

×： 表示该有毒有害物质至少在该部件的某一均质材料中的含量超出SJ/T 11363-2006 标准规定的限量要求。
Indicates that the concentration of the hazardous substance of at least one of all homogeneous materials in the parts is above the relevant threshold of the SJ/T 11363-2006 standard.

对销售之日的所售产品, 本表显示,

凯创供应链的电子信息产品可能包含这些物质。注意: 在所售产品中可能会也可能不会含有所有所列的部件。

This table shows where these substances may be found in the supply chain of Enterasys' electronic information products, as of the date of sale of the enclosed product. Note that some of the component types listed above may or may not be a part of the enclosed product.

除非另外特别的标注, 此标志为针对所涉及产品的环保使用期标志。某些零部件会有一个不同的环保使用期(例如, 电池单元模块)贴在其产品上。

此环保使用期限只适用于产品是在产品手册中所规定的条件下工作。

The Environmentally Friendly Use Period (EFUP) for all enclosed products and their parts are per the symbol shown here, unless otherwise marked. Certain parts may have a different EFUP (for example, battery modules) and so are marked to reflect such. The Environmentally Friendly Use Period is valid only when the product is operated under the conditions defined in the product manual.



VCCI NOTICE

This is a class A product based on the standard of the Voluntary Control Council for Interference by Information Technology Equipment (VCCI). If this equipment is used in a domestic environment, radio disturbance may arise. When such trouble occurs, the user may be required to take corrective actions.

この装置は、情報処理装置等電波障害自主規制協議会（VCCI）の基準に基づくクラスA情報技術装置です。この装置を家庭環境で使用すると電波妨害を引き起こすことがあります。この場合には使用者が適切な対策を講ずるよう要求されることがあります。

BSMI EMC STATEMENT — TAIWAN

This is a class A product. In a domestic environment this product may cause radio interference in which case the user may be required to take adequate measures.

警告使用者：

這是甲類的資訊產品，在居住的環境中使用時，可能會造成射頻干擾，在這種情況下，使用者會被要求採取某些適當的對策。

SAFETY INFORMATION CLASS 1 LASER TRANSCEIVERS

**SINGLE MODE NETWORK EXPANSION MODULES USE CLASS 1 LASER TRANSCEIVERS.
READ THE FOLLOWING SAFETY INFORMATION
BEFORE INSTALLING OR OPERATING THESE MODULES.**

The Class 1 laser transceivers use an optical feedback loop to maintain Class 1 operation limits. This control loop eliminates the need for maintenance checks or adjustments. The output is factory set, and does not allow any user adjustment. Class 1 Laser transceivers comply with the following safety standards:

- 21 CFR 1040.10 and 1040.11 U.S. Department of Health and Human Services (FDA).
- IEC Publication 825 (International Electrotechnical Commission).
- CENELEC EN 60825 (European Committee for Electrotechnical Standardization).

When operating within their performance limitations, laser transceiver output meets the Class 1 accessible emission limit of all three standards. Class 1 levels of laser radiation are not considered hazardous.

When the connector is in place, all laser radiation remains within the fiber. The maximum amount of radiant power exiting the fiber (under normal conditions) is -12.6 dBm or 55×10^{-6} watts.

Removing the optical connector from the transceiver allows laser radiation to emit directly from the optical port. The maximum radiance from the optical port (under worst case conditions) is 0.8 W cm^{-2} or $8 \times 10^3 \text{ W m}^2 \text{ sr}^{-1}$.

Do not use optical instruments to view the laser output. The use of optical instruments to view laser output increases eye hazard. When viewing the output optical port, power must be removed from the network adapter.

DECLARATION OF CONFORMITY

Application of Council Directive(s): **89/336/EEC**
73/23/EEC

Manufacturer's Name: **Enterasys Networks, Inc.**

Manufacturer's Address: **50 Minuteman Road**
Andover, MA 01810
USA

European Representative Address: **Enterasys Networks, Ltd.**
Nexus House, Newbury Business Park
London Road, Newbury
Berkshire RG14 2PZ, England

Conformance to Directive(s)/Product Standards: **EC Directive 89/336/EEC**
EN 55022
EN 61000-3-2
EN 61000-3-3
EN 55024
EC Directive 73/23/EEC
EN 60950
EN 60825

Equipment Type/Environment: **Networking Equipment, for use in a Commercial**
or Light Industrial Environment.

Enterasys Networks, Inc. declares that the equipment packaged with this notice conforms to the above directives.

ENTERASYS NETWORKS, INC. FIRMWARE LICENSE AGREEMENT

BEFORE OPENING OR UTILIZING THE ENCLOSED PRODUCT, CAREFULLY READ THIS LICENSE AGREEMENT.

This document is an agreement (“Agreement”) between the end user (“You”) and Enterasys Networks, Inc. on behalf of itself and its Affiliates (as hereinafter defined) (“Enterasys”) that sets forth Your rights and obligations with respect to the Enterasys software program/firmware installed on the Enterasys product (including any accompanying documentation, hardware or media) (“Program”) in the package and prevails over any additional, conflicting or inconsistent terms and conditions appearing on any purchase order or other document submitted by You. “Affiliate” means any person, partnership, corporation, limited liability company, or other form of enterprise that directly or indirectly through one or more intermediaries, controls, or is controlled by, or is under common control with the party specified. This Agreement constitutes the entire understanding between the parties, and supersedes all prior discussions, representations, understandings or agreements, whether oral or in writing, between the parties with respect to the subject matter of this Agreement. The Program may be contained in firmware, chips or other media.

BY INSTALLING OR OTHERWISE USING THE PROGRAM, YOU REPRESENT THAT YOU ARE AUTHORIZED TO ACCEPT THESE TERMS ON BEHALF OF THE END USER (IF THE END USER IS AN ENTITY ON WHOSE BEHALF YOU ARE AUTHORIZED TO ACT, “YOU” AND “YOUR” SHALL BE DEEMED TO REFER TO SUCH ENTITY) AND THAT YOU AGREE THAT YOU ARE BOUND BY THE TERMS OF THIS AGREEMENT, WHICH INCLUDES, AMONG OTHER PROVISIONS, THE LICENSE, THE DISCLAIMER OF WARRANTY AND THE LIMITATION OF LIABILITY. IF YOU DO NOT AGREE TO THE TERMS OF THIS AGREEMENT OR ARE NOT AUTHORIZED TO ENTER INTO THIS AGREEMENT, ENTERASYS IS UNWILLING TO LICENSE THE PROGRAM TO YOU AND YOU AGREE TO RETURN THE UNOPENED PRODUCT TO ENTERASYS OR YOUR DEALER, IF ANY, WITHIN TEN (10) DAYS FOLLOWING THE DATE OF RECEIPT FOR A FULL REFUND.

IF YOU HAVE ANY QUESTIONS ABOUT THIS AGREEMENT, CONTACT ENTERASYS NETWORKS, LEGAL DEPARTMENT AT (978) 684-1000.

You and Enterasys agree as follows:

1. **LICENSE.** You have the non-exclusive and non-transferable right to use only the one (1) copy of the Program provided in this package subject to the terms and conditions of this Agreement.
2. **RESTRICTIONS.** Except as otherwise authorized in writing by Enterasys, You may not, nor may You permit any third party to:
 - (i) Reverse engineer, decompile, disassemble or modify the Program, in whole or in part, including for reasons of error correction or interoperability, except to the extent expressly permitted by applicable law and to the extent the parties shall not be permitted by that applicable law, such rights are expressly excluded. Information necessary to achieve interoperability or correct errors is available from Enterasys upon request and upon payment of Enterasys’ applicable fee.
 - (ii) Incorporate the Program, in whole or in part, in any other product or create derivative works based on the Program, in whole or in part.
 - (iii) Publish, disclose, copy, reproduce or transmit the Program, in whole or in part.
 - (iv) Assign, sell, license, sublicense, rent, lease, encumber by way of security interest, pledge or otherwise transfer the Program, in whole or in part.
 - (v) Remove any copyright, trademark, proprietary rights, disclaimer or warning notice included on or embedded in any part of the Program.

3. **APPLICABLE LAW.** This Agreement shall be interpreted and governed under the laws and in the state and federal courts of the Commonwealth of Massachusetts without regard to its conflicts of laws provisions. You accept the personal jurisdiction and venue of the Commonwealth of Massachusetts courts. None of the 1980 United Nations Convention on Contracts for the International Sale of Goods, the United Nations Convention on the Limitation Period in the International Sale of Goods, and the Uniform Computer Information Transactions Act shall apply to this Agreement.

4. **EXPORT RESTRICTIONS.** You understand that Enterasys and its Affiliates are subject to regulation by agencies of the U.S. Government, including the U.S. Department of Commerce, which prohibit export or diversion of certain technical products to certain countries, unless a license to export the Program is obtained from the U.S. Government or an exception from obtaining such license may be relied upon by the exporting party.

If the Program is exported from the United States pursuant to the License Exception CIV under the U.S. Export Administration Regulations, You agree that You are a civil end user of the Program and agree that You will use the Program for civil end uses only and not for military purposes.

If the Program is exported from the United States pursuant to the License Exception TSR under the U.S. Export Administration Regulations, in addition to the restriction on transfer set forth in Sections 1 or 2 of this Agreement, You agree not to (i) reexport or release the Program, the source code for the Program or technology to a national of a country in Country Groups D:1 or E:2 (Albania, Armenia, Azerbaijan, Belarus, Bulgaria, Cambodia, Cuba, Estonia, Georgia, Iraq, Kazakhstan, Kyrgyzstan, Laos, Latvia, Libya, Lithuania, Moldova, North Korea, the People's Republic of China, Romania, Russia, Rwanda, Tajikistan, Turkmenistan, Ukraine, Uzbekistan, Vietnam, or such other countries as may be designated by the United States Government), (ii) export to Country Groups D:1 or E:2 (as defined herein) the direct product of the Program or the technology, if such foreign produced direct product is subject to national security controls as identified on the U.S. Commerce Control List, or (iii) if the direct product of the technology is a complete plant or any major component of a plant, export to Country Groups D:1 or E:2 the direct product of the plant or a major component thereof, if such foreign produced direct product is subject to national security controls as identified on the U.S. Commerce Control List or is subject to State Department controls under the U.S. Munitions List.

5. **UNITED STATES GOVERNMENT RESTRICTED RIGHTS.** The enclosed Program (i) was developed solely at private expense; (ii) contains "restricted computer software" submitted with restricted rights in accordance with section 52.227-19 (a) through (d) of the Commercial Computer Software-Restricted Rights Clause and its successors, and (iii) in all respects is proprietary data belonging to Enterasys and/or its suppliers. For Department of Defense units, the Program is considered commercial computer software in accordance with DFARS section 227.7202-3 and its successors, and use, duplication, or disclosure by the Government is subject to restrictions set forth herein.

6. **DISCLAIMER OF WARRANTY.** EXCEPT FOR THOSE WARRANTIES EXPRESSLY PROVIDED TO YOU IN WRITING BY ENTERASYS, ENTERASYS DISCLAIMS ALL WARRANTIES, EITHER EXPRESS OR IMPLIED, INCLUDING BUT NOT LIMITED TO IMPLIED WARRANTIES OF MERCHANTABILITY, SATISFACTORY QUALITY, FITNESS FOR A PARTICULAR PURPOSE, TITLE AND NON- INFRINGEMENT WITH RESPECT TO THE PROGRAM. IF IMPLIED WARRANTIES MAY NOT BE DISCLAIMED BY APPLICABLE LAW, THEN ANY IMPLIED WARRANTIES ARE LIMITED IN DURATION TO THIRTY (30) DAYS AFTER DELIVERY OF THE PROGRAM TO YOU.

7. **LIMITATION OF LIABILITY.** IN NO EVENT SHALL ENTERASYS OR ITS SUPPLIERS BE LIABLE FOR ANY DAMAGES WHATSOEVER (INCLUDING, WITHOUT LIMITATION, DAMAGES FOR LOSS OF BUSINESS, PROFITS, BUSINESS INTERRUPTION, LOSS OF BUSINESS INFORMATION, SPECIAL, INCIDENTAL, CONSEQUENTIAL, OR RELIANCE DAMAGES, OR OTHER LOSS) ARISING OUT OF THE USE OR INABILITY TO USE THE PROGRAM, EVEN IF ENTERASYS HAS BEEN ADVISED OF THE POSSIBILITY OF SUCH DAMAGES. THIS FOREGOING LIMITATION SHALL APPLY REGARDLESS OF THE CAUSE OF ACTION UNDER WHICH DAMAGES ARE SOUGHT.

THE CUMULATIVE LIABILITY OF ENTERASYS TO YOU FOR ALL CLAIMS RELATING TO THE PROGRAM, IN CONTRACT, TORT OR OTHERWISE, SHALL NOT EXCEED THE TOTAL AMOUNT OF FEES PAID TO ENTERASYS BY YOU FOR THE RIGHTS GRANTED HEREIN.

8. **AUDIT RIGHTS.** You hereby acknowledge that the intellectual property rights associated with the Program are of critical value to Enterasys and, accordingly, You hereby agree to maintain complete books, records and accounts showing (i) license fees due and paid, and (ii) the use, copying and deployment of the Program. You also grant to Enterasys and its authorized representatives, upon reasonable notice, the right to audit and examine during Your normal business hours, Your books, records, accounts and hardware devices upon which the Program may be deployed to verify compliance with this Agreement, including the verification of the license fees due and paid Enterasys and the use, copying and deployment of the Program. Enterasys' right of examination shall be exercised reasonably, in good faith and in a manner calculated to not unreasonably interfere with Your business. In the event such audit discovers non-compliance with this Agreement, including copies of the Program made, used or deployed in breach of this Agreement, You shall promptly pay to Enterasys the appropriate license fees. Enterasys reserves the right, to be exercised in its sole discretion and without prior notice, to terminate this license, effective immediately, for failure to comply with this Agreement. Upon any such termination, You shall immediately cease all use of the Program and shall return to Enterasys the Program and all copies of the Program.

9. **OWNERSHIP.** This is a license agreement and not an agreement for sale. You acknowledge and agree that the Program constitutes trade secrets and/or copyrighted material of Enterasys and/or its suppliers. You agree to implement reasonable security measures to protect such trade secrets and copyrighted material. All right, title and interest in and to the Program shall remain with Enterasys and/or its suppliers. All rights not specifically granted to You shall be reserved to Enterasys.

10. **ENFORCEMENT.** You acknowledge and agree that any breach of Sections 2, 4, or 9 of this Agreement by You may cause Enterasys irreparable damage for which recovery of money damages would be inadequate, and that Enterasys may be entitled to seek timely injunctive relief to protect Enterasys' rights under this Agreement in addition to any and all remedies available at law.

11. **ASSIGNMENT.** You may not assign, transfer or sublicense this Agreement or any of Your rights or obligations under this Agreement, except that You may assign this Agreement to any person or entity which acquires substantially all of Your stock or assets. Enterasys may assign this Agreement in its sole discretion. This Agreement shall be binding upon and inure to the benefit of the parties, their legal representatives, permitted transferees, successors and assigns as permitted by this Agreement. Any attempted assignment, transfer or sublicense in violation of the terms of this Agreement shall be void and a breach of this Agreement.

12. **WAIVER.** A waiver by Enterasys of a breach of any of the terms and conditions of this Agreement must be in writing and will not be construed as a waiver of any subsequent breach of such term or condition. Enterasys' failure to enforce a term upon Your breach of such term shall not be construed as a waiver of Your breach or prevent enforcement on any other occasion.

13. **SEVERABILITY.** In the event any provision of this Agreement is found to be invalid, illegal or unenforceable, the validity, legality and enforceability of any of the remaining provisions shall not in any way be affected or impaired thereby, and that provision shall be reformed, construed and enforced to the maximum extent permissible. Any such invalidity, illegality or unenforceability in any jurisdiction shall not invalidate or render illegal or unenforceable such provision in any other jurisdiction.

14. **TERMINATION.** Enterasys may terminate this Agreement immediately upon Your breach of any of the terms and conditions of this Agreement. Upon any such termination, You shall immediately cease all use of the Program and shall return to Enterasys the Program and all copies of the Program.

About This Guide

Who Should Use This Guide	xv
How to Use This Guide	xvi
Related Documents	xvi
Conventions Used in This Guide	xvii

Chapter 1: Introduction

Overview	1-2
B2G124-24 and B2G124-48	1-2
B2H124-48	1-4
High-Speed Stack Connections	1-5
Redundant Power Supply Capability	1-5
Connectivity	1-5
Management	1-7
Switch Configuration Using WebView	1-7
Switch Configuration Using CLI Commands	1-7
Standards Compatibility	1-7
LANVIEW Diagnostic LEDs	1-7
Getting Help	1-8

Chapter 2: Network Requirements

10BASE-T Network	2-1
100BASE-TX Network	2-2
1000BASE-FX Network	2-2
1000BASE-T Network	2-2

Chapter 3: Hardware Installation

Considerations Prior to Installation	3-2
Required Tools	3-2
Unpacking the Switch	3-2
Installing Optional Mini-GBICs	3-3
Installing the Switch on a Flat Surface	3-6
Installing the Rubber Feet	3-6
Guidelines for Flat Surface Installation	3-8
Rack Mounting the Switch	3-9
Guidelines for Rackmount Installation	3-9
Attaching Brackets and Installing in Rack	3-9
Connecting High-Speed Stacking Cables	3-10
Configuring Switches in a Stack	3-12
About SecureStack B2 Switch Operation in a Stack	3-12
Recommended Procedures for New and Existing Stacks	3-14

Connecting AC and RPS-SYS Power	3-15
AC Power	3-15
C2RPS-SYS Redundant Power System	3-17
Stack Initialization Overview	3-17
Connecting to Console Port for Local Management	3-18
What Is Needed	3-18
Connecting to an IBM or Compatible Device	3-19
Connecting to a VT Series Terminal	3-20
Connecting to a Modem	3-21
Connecting to the Network	3-22
Connecting UTP Cables	3-22
Connecting Fiber-Optic Cables to MT-RJ Ports	3-26
Connecting Fiber-Optic Cables to LC Ports	3-28
Completing the Installation	3-31

Chapter 4: Troubleshooting

Using LANVIEW	4-2
Troubleshooting Checklist	4-6
Using the Reset Switch	4-8

Appendix A: Specifications

Switch Specifications	A-1
Mini-GBIC Input/Output Specifications	A-3
Gigabit Ethernet Specifications	A-4
MGBIC-LC01/MGBIC-MT01 Specifications (1000BASE-SX)	A-4
MGBIC-LC03 Specifications (1000BASE-SX)	A-5
MGBIC-LC09 Specifications (1000BASE-LX)	A-5
MGBIC-08 Specifications (1000BASE-ELX)	A-6
MGBIC-02 Specifications (1000BASE-T)	A-7
Console Port Pinout Assignments	A-7
Regulatory Compliance	A-8

Index

Figures

1-1	B2G124-24 Stackable Switch	1-3
1-2	B2G124-48 Stackable Switch	1-3
1-3	B2H124-48 Stackable Switch.....	1-4
3-1	Mini-GBIC with MT-RJ Connector.....	3-4
3-2	Mini-GBIC with LC Connector	3-5
3-3	Chassis Bottom, Rubber Feet Placement.....	3-7
3-4	Area Guidelines for Switch Installation on Flat Surface	3-8
3-5	Attaching the Rackmount Brackets.....	3-10
3-6	Fastening the Switch to the Rack.....	3-10
3-7	High-Speed Stacking Cable Connections	3-12
3-8	Switch Rear View	3-16
3-9	DB9 Male Console Port Pinout Assignments.....	3-19
3-10	Connecting an IBM PC or Compatible	3-20
3-11	Connecting a VT Series Terminal	3-21
3-12	Connecting to a Modem.....	3-22
3-13	Connecting a UTP Cable Segment to RJ45 Port.....	3-23
3-14	Four-Wire Crossover Cable RJ45 Pinouts for 10/100BASE-TX	3-24
3-15	Four-Wire Straight-Through Cable RJ45 Pinouts for 10/100BASE-TX.....	3-24
3-16	Eight-Wire Crossover Cable RJ45 Pinouts for 10/100/1000BASE-TX.....	3-25
3-17	Eight-Wire Straight-Through Cable RJ45 Pinouts for 10/100/1000BASE-TX.....	3-25
3-18	Cable Connection to MT-RJ Multimode Fiber-Optic Connectors	3-27
3-19	Cable Connection to LC Fiber-Optic Connectors.....	3-30
4-1	LANVIEW LEDs of B2G124-24 and B2G124-48 (B2G124-24 shown).....	4-2
4-2	LANVIEW LEDs of B2H124-48	4-3
4-3	Reset Switch	4-8
A-1	Console Port Pinout Assignments.....	A-8

Tables

1-1	Description of Mini-GBICs.....	1-6
3-1	Contents of Switch Carton	3-2
4-1	LANVIEW LEDs	4-4
4-2	Troubleshooting Checklist.....	4-6
A-1	Switch Specifications	A-2
A-2	Mini-GBIC Input/Output Port Specifications	A-4
A-3	MGBIC-LC01/MGBIC-MT01 Optical Specifications	A-5
A-4	MGBIC-LC01/MGBIC-MT01 Operating Range	A-5
A-5	MGBIC-LC03 Optical Specifications	A-5
A-6	MGBIC-LC03 Operating Range	A-6
A-7	MGBIC-LC09 Optical Specifications	A-6
A-8	MGBIC-LC09 Operating Range	A-6
A-9	MGBIC-08 Optical Specifications.....	A-7
A-10	MGBIC-08 Operating Range.....	A-7
A-11	MGBIC-02 Specifications	A-7
A-12	Compliance Standards.....	A-8

About This Guide

This guide provides an overview, installation and troubleshooting instructions, and specifications for the Enterasys[®] SecureStack B2G124-24, B2G124-48, and B2H124-48 stackable Ethernet switches.

For information about the Command Line Interface (CLI) set of commands used to configure and manage the switches, refer to the Enterasys Networks[®] *SecureStack B2 Configuration Guide*.



Note: In this guide, the following terms are used:

- *Switch* refers to all three switches (B2G124-24, B2G124-48, and B2H124-48) unless otherwise noted.
- *MGBIC* (Mini-Gigabit Interface Card) refers to optional small form pluggable (SFP) interface modules that plug into the fixed front panel MGBIC slots.

Important Notice

Depending on the firmware version used in the B2G124-24, B2G124-48, and B2H124-48 switches, some features described in this document may not be supported. Refer to the Release Notes shipped with the switch to determine which features are supported.

Who Should Use This Guide

This guide is intended for a network administrator responsible for installing and setting up the stackable switches.



Electrical Hazard: Only qualified personnel should perform installation procedures.

Riesgo Electrico: Solamente personal calificado debe realizar procedimientos de instalacion.

Elektrischer Gefahrenhinweis: Installationen sollten nur durch ausgebildetes und qualifiziertes Personal vorgenommen werden.

How to Use This Guide

Read through this guide completely to familiarize yourself with its contents and gain an understanding of the features and capabilities of the stackable Ethernet switches. A general knowledge of data communications networks is helpful when setting up the switches.

This preface provides an overview of this guide and the SecureStack B2 manual set, a brief summary of each chapter and defines the conventions used throughout this guide. To locate information concerning various subjects in this guide, refer to the following table:

For...	Refer to...
An overview of the switch features and how to obtain technical support	Chapter 1, Introduction
Network requirements that must be met before installing the switch	Chapter 2, Network Requirements
Instructions to install the switch on a flat surface or in a standard 19-inch rack and configure the switch in a stacked configuration	Chapter 3, Hardware Installation
Troubleshooting installation problems and diagnosing network/operational problems using the LANVIEW LEDs	Chapter 4, Troubleshooting
Specifications, environmental requirements, and physical properties of the switch and optional Mini-GBICs	Appendix A, Specifications

Related Documents

The manuals listed above can be obtained from the World Wide Web in Adobe Acrobat Portable Document Format (PDF) at the following site:

<http://www.enterasys.com/support/manuals>

- *SecureStack B2 Configuration Guide* describes how to use the Command Line Interface (CLI) to set up and manage the B2 switches.
- *Cabling Guide* provides information concerning network cabling, dB loss, and other cabling specifications and usage.

Unlike the *SecureStack B2 Configuration Guide*, the *Cabling Guide* is not listed alphabetically on the web site. Instead, it is under the *Overview Guides* link.

Conventions Used in This Guide

The following conventions are used in this guide:



Note: Calls the reader's attention to any item of information that may be of special importance.



Caution: Contains information essential to avoid damage to the equipment.

Precaución: Contiene información esencial para prevenir dañar el equipo.

Achtung: Verweist auf wichtige Informationen zum Schutz gegen Beschädigungen.



Electrical Hazard: Warns against an action that could result in personal injury or death due to an electrical hazard.

Riesgo Eléctrico: Advierte contra una acción que pudiera resultar en lesión corporal o la muerte debido a un riesgo eléctrico.

Elektrischer Gefahrenhinweis: Warnung vor sämtlichen Handlungen, die zu Verletzung von Personen oder Todesfällen – hervorgerufen durch elektrische Spannung – führen können!



Warning: Warns against an action that could result in personal injury or death.

Advertencia: Advierte contra una acción que pudiera resultar en lesión corporal o la muerte.

Warhinweis: Warnung vor Handlungen, die zu Verletzung von Personen oder gar Todesfällen führen können!

Introduction

This chapter introduces the B2G124-24, B2G124-48, and B2H124-48 stackable switches.

Important Notice

Depending on the firmware version used in the switch, some features described in this document may not be supported. Refer to the Release Notes shipped with the B2G124-24, B2G124-48, and B2H124-48 to determine which features are supported.

For information about...	Refer to page...
Overview	1-2
Connectivity	1-5
Management	1-7
Standards Compatibility	1-7
LANVIEW Diagnostic LEDs	1-7
Getting Help	1-8

Overview

The B2G124-24, B2G124-48, and B2H124-48 are stackable Fast Ethernet and Gigabit Ethernet switches, which can be adapted and scaled to help meet your network needs. These switches provide a management platform and uplink to a network backbone for a stacked group of up to eight B2 switches. The four built-in Small Form Pluggable (SFP) interface slots provide you with the option of installing Mini-GBICs for 1000BASE-SX/LX fiber-optic connections and 1000BASE-T copper connections.

The switches also support the use of a redundant DC power supply to help prevent downtime due to an internal power supply failure in the switch or AC power source.

You can install the switch on a flat surface or into a standard 19-inch rack with user-supplied mounting hardware, and configure the switch functions using the WebView™ application, CLI switching commands, and/or SNMP.

B2G124-24 and B2G124-48

The B2G124-24 (Figure 1-1) and B2G124-48 (Figure 1-2) have several types of front and rear panel port connections, which include:

- RJ45 ports (10/100/1000 Mbps, 1000BASE-T copper ports), 24 on the B2G124-24 and 48 on the B2G124-48
- SFP slots that provide you with the option of installing Small Form Pluggable (SFP) Mini-GBICs for 1000BASE-SX/LX fiber-optic connections and 1000BASE-T copper connections.
- Rear panel connectors for high-speed connections in a stack configuration
- Rear panel Redundant Power Supply connector for a connection to a SecureStack C2RPS-SYS power supply system using the appropriate cable (C2RPS-PSM).



Caution: The B2G124-24, B2G124-48 and B2H124-48 are not PoE-compliant devices. Do not connect a SecureStack C2 PoE Redundant Power System (C2RPS-POE) to the power connector. Otherwise, damage to the device may result.

Precaución: Los dispositivos B2G124-24, B2G124-48 y B2H124-48 **no cumplen** con el estándar PoE (power over ethernet). **No conecte** una fuente de poder redundante (RPS) SecureStack C2 PoE (C2RPS-POE) al cable de corriente. De lo contrario, el dispositivo puede dañarse.

The 10/100/1000 Mbps fixed front panel ports can operate in either half-duplex or full-duplex mode, as determined by Auto-Negotiation.



Note: The Mini-GBIC ports cannot be active simultaneously with their corresponding 10/100/1000BASE-T ports. For example, if SFP port 24 establishes a link first on the B2G124-24, the 10/100/1000BASE-T built-in RJ45 port 24 is not available and vice-versa.

Figure 1-1 B2G124-24 Stackable Switch

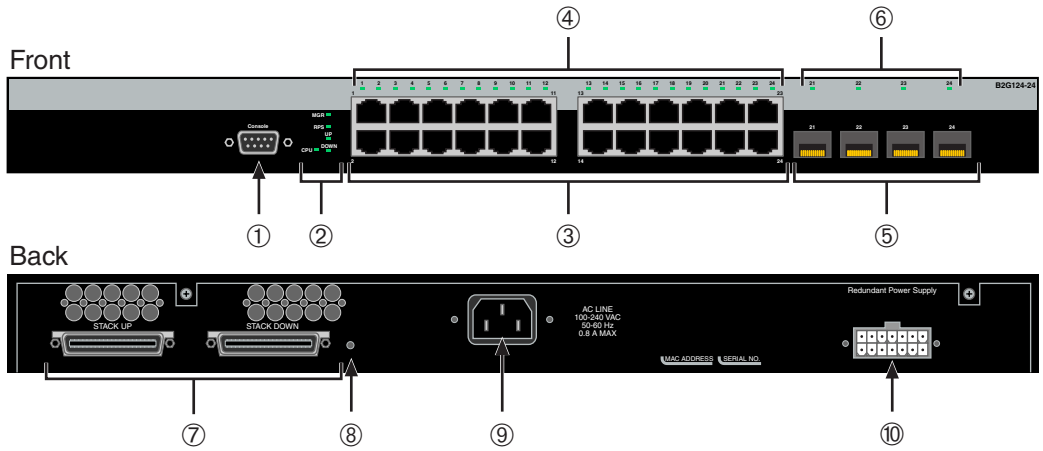

- | | |
|---|-----------------------------------|
| 1 DB9 RS232 Console port connector | 6 Mini-GBIC port status LEDs |
| 2 Status LEDs | 7 Two ports for stack connections |
| 3 Twenty-four RJ45, 10/100/1000 Mbps ports | 8 Reset switch |
| 4 RJ45 port status LEDs | 9 AC power input connector |
| 5 Four slots for SFP interface modules (Mini-GBICs) | 10 C2RPS-SYS connection |

Figure 1-2 B2G124-48 Stackable Switch

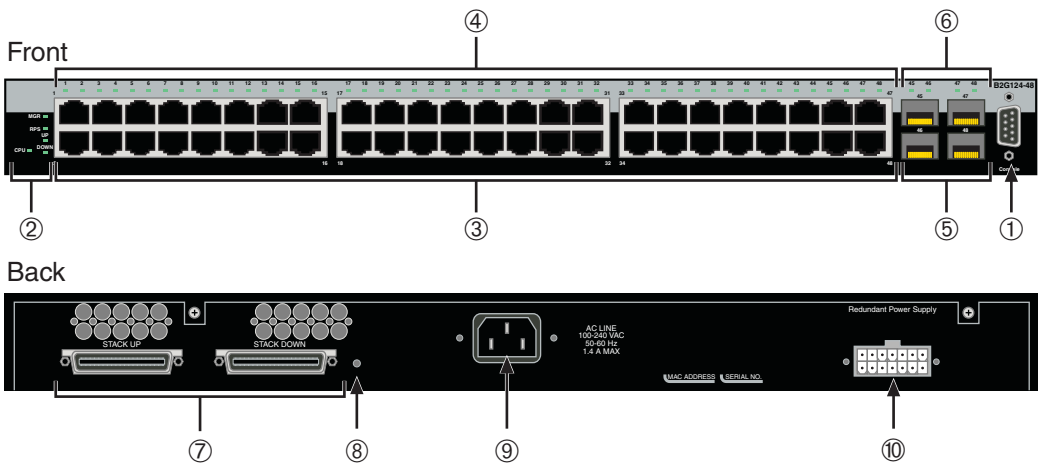

- | | |
|---|-----------------------------------|
| 1 DB9 RS232 Console port connector | 6 Mini-GBIC port status LEDs |
| 2 Status LEDs | 7 Two ports for stack connections |
| 3 Forty-eight RJ45, 10/100/1000 Mbps ports | 8 Reset switch |
| 4 RJ45 port status LEDs | 9 AC power input connector |
| 5 Four slots for SFP interface modules (Mini-GBICs) | 10 C2RPS-SYS connection |

B2H124-48

The B2H124-48 (Figure 1-3) has the following front and rear panel port connections:

- RJ45 ports (10/100 Mbps 100BASE-TX copper ports).
- SFP slots that provide you with the option of installing Small Form Pluggable (SFP) Mini-GBICs for 1000BASE-SX/LX fiber-optic connections and 1000BASE-T copper connections.
- Rear panel connectors for high-speed connections in a stack configuration.
- Rear panel Redundant Power Supply connector for a connection to a SecureStack C2RPS-SYS power supply system using the appropriate cable (C2RPS-PSM).



Caution: The B2G124-24, B2G124-48 and B2H124-48 are not PoE-compliant devices. Do not connect a SecureStack C2 PoE Redundant Power System (C2RPS-POE) to the power connector. Otherwise, damage to the device may result.

Precaución: Los dispositivos B2G124-24, B2G124-48 y B2H124-48 **no cumplen** con el estándar PoE (power over ethernet). **No conecte** una fuente de poder redundante (RPS) SecureStack C2 PoE (C2RPS-POE) al cable de corriente. De lo contrario, el dispositivo puede dañarse.

The 10/100 Mbps fixed front panel ports can operate in either half-duplex or full-duplex mode, as determined by Auto-Negotiation.

Figure 1-3 B2H124-48 Stackable Switch

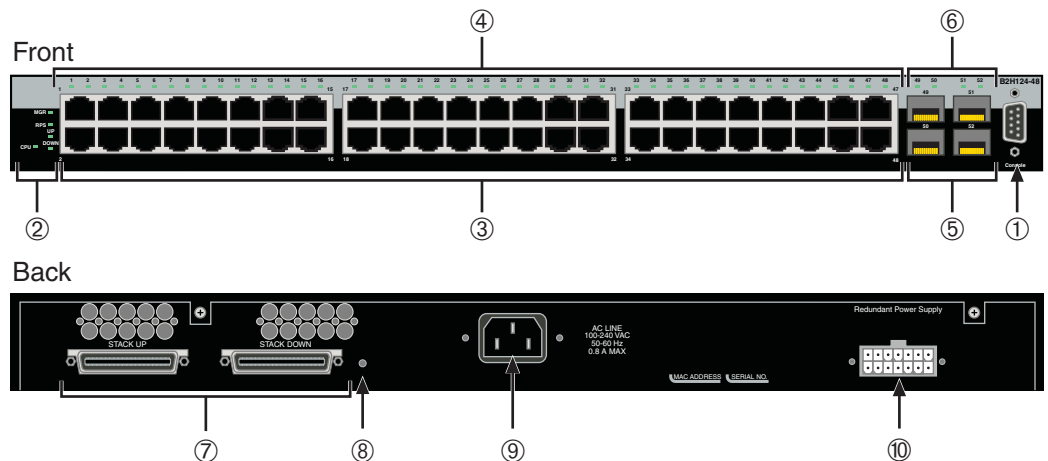

- | | |
|---|--|
| 1 DB9 RS232 console port connector | 6 Mini-GBIC port status LEDs |
| 2 Status LEDs | 7 Two ports for stack connections |
| 3 Forty-eight RJ45, 10/100 Mbps ports | 8 Reset switch |
| 4 RJ45 port status LEDs | 9 AC power input connector |
| 5 Four slots for SFP interface modules (Mini-GBICs) | 10 Connection for a C2RPS-SYS redundant power supply |

High-Speed Stack Connections

The switches have rear-panel connectors for high-speed connections in a stack configuration. The high-speed stacking cables used for the connections are optional items and must be ordered separately. Stacking cables are available in three lengths: 1 foot, 1 meter and 5 meters. See “[Connecting High-Speed Stacking Cables](#)” on page 3-10 for details on these cables.

Redundant Power Supply Capability

The switch has power supply redundancy capability when connected to an optional external redundant power supply (RPS). If the internal power supply fails, the RPS assumes the entire load of the switch without interrupting network traffic. The internal power supply and RPS each have their own AC power connection, which enables the connection of each power supply to a different AC power circuit for additional AC power source redundancy.

Connectivity

The switch connects to Ethernet networks or workstations via the fixed front panel RJ45 connectors and four uplink ports that support optional Mini-GBICs.

At the time of this printing, the Mini-GBICs that are available from Enterasys and supported by B2 switches are described in [Table 1-1](#) on page 1-6. These Mini-GBICs meet or exceed the IEEE 802.3z-1998 standard.

Table 1-1 Description of Mini-GBICs

Mini-GBIC	Specification
MGBIC-LC01	Provides one 1000BASE-SX compliant LC fiber-optic multimode port and a standard LC connector. For optical and operating range specifications, refer to “MGBIC-LC01/MGBIC-MT01 Specifications (1000BASE-SX)” on page A-4.
MGBIC-LC03	Provides one 1000BASE-SX compliant LC fiber-optic multimode port with a standard LC duplex connector. For optical and operating range specifications, refer to “MGBIC-LC03 Specifications (1000BASE-SX)” on page A-5.
MGBIC-LC09	Provides one 1000BASE-LX compliant LC fiber-optic single-mode port with a standard LC connector. For optical and operating range specifications, refer to “MGBIC-LC09 Specifications (1000BASE-LX)” on page A-6.
MGBIC-MT01	Provides one 1000BASE-SX compliant LC fiber-optic multimode port with a standard MT-RJ connector. For optical and operating range specifications, refer to “MGBIC-LC01/MGBIC-MT01 Specifications (1000BASE-SX)” on page A-4.
MGBIC-08	Provides one 1000BASE-ELX compliant LC fiber-optic single-mode port with a standard LC connector. For optical and operating range specifications, refer to “MGBIC-08 Specifications (1000BASE-ELX)” on page A-6.
MGBIC-02	Provides one RJ45 copper connection that is compliant with the 1000BASE-T standard RJ45 connector. For operating range specifications, refer to “MGBIC-02 Specifications (1000BASE-T)” on page A-7 .

Management

Management of the module can be either in-band or out-of-band. In-band remote management is possible using Telnet, Enterasys Networks' NetSight[®] management application, or the WebView application. Out-of-band management is provided through the DB9 Console port connector on the front panel using a VT100 terminal or a VT100 terminal emulator.

Switch Configuration Using WebView

Enterasys Networks' HTTP-based Web management application (WebView) is an intuitive web tool for simple management tasks.

Switch Configuration Using CLI Commands

The CLI commands enable you to perform more complete switch configuration management tasks.

For CLI command set information and how to configure the module, refer to the *SecureStack B2 Configuration Guide*.

Standards Compatibility

The 1000BASE-T ports are compliant with the following standards and operations:

- IEEE 802.3
- IEEE 802.3u
- IEEE 802.3ab
- Full-Duplex operation

The SFP ports are compliant with the following standards and operations:

- IEEE 802.3z
- IEEE 802.3x Flow Control support for Full-Duplex mode
- Auto-negotiation for Full-Duplex control operations

LANVIEW Diagnostic LEDs

LANVIEW diagnostic LEDs serve as an important troubleshooting aid by providing an easy way to observe the status of individual ports and overall network operations.

Getting Help

For additional support related to the switches or this document, contact Enterasys Networks using one of the following methods:

World Wide Web	www.enterasys.com/services/support/
Phone	1-800-872-8440 (toll-free in U.S. and Canada) or 1-978-684-1000 For the Enterasys Networks Support toll-free number in your country: www.enterasys.com/services/support/contact/
Internet mail	support@enterasys.com To expedite your message, type [SWITCHING] in the subject line.

To send comments concerning this document to the Technical Publications Department:
techpubs@enterasys.com

Please include the document Part Number in your email message.

Before contacting Enterasys Networks for technical support, have the following information ready:

- Your Enterasys Networks service contract number
- A description of the failure
- A description of any action(s) already taken to resolve the problem (for example, changing mode switches, rebooting the unit, etc.)
- The serial and revision numbers of all involved Enterasys Networks products in the network
- A description of your network environment (layout, cable type, etc.)
- Network load and frame size at the time of trouble (if known)
- The device history (that is, have you returned the device before, is this a recurring problem, and so forth.)
- Any previous Return Material Authorization (RMA) numbers

Network Requirements

Before installing the device, review the requirements and specifications in this chapter concerning the following:

For information about...	Refer to page...
10BASE-T Network	2-1
100BASE-TX Network	2-2
1000BASE-FX Network	2-2
1000BASE-T Network	2-2



Note: The network installation must meet the requirements described in this chapter to ensure satisfactory performance of this equipment. Failure to do so will produce poor network performance.



Note: The *SecureStack B2 Configuration Guide* and the *Cabling Guide* referred to in the following sections can be found on the Enterasys Networks World Wide Web site: <http://www.enterasys.com/support/manuals>

For details about obtaining the manuals, refer to “[Related Documents](#)” on page xvi.

10BASE-T Network

When connecting a 10BASE-TX segment to one of the RJ45 fixed ports (1 through 24 on B2G124-24, 1 through 48 on B2G124-48, or 1 through 48 on B2H124-48), ensure that the network meets the Ethernet network requirements of the IEEE 802.3-2002 standard for 10BASE-TX. Refer to the *Cabling Guide* for details.



Note: If a port is to operate at 100 or 1000 Mbps, Category 5 cabling must be used. Category 3 cabling does not meet the 100 or 1000 Mbps specifications. For 10 Mbps operation only, Category 3, Category 4, or Category 5 cabling can be used. Refer to [100BASE-TX Network](#) (page 2-2) and [1000BASE-T Network](#) (page 2-2) for information about 100BASE-TX and 1000BASE-T networks and cabling.

100BASE-TX Network

When connecting a 100BASE-TX segment to one of the fixed ports (1 through 24 on B2G124-24, 1 through 48 on B2G124-48, or 1 through 48 on B2H124-48), use Category 5 UTP cabling. The switch at the other end of the twisted pair segment must meet IEEE 802.3-2002 100BASE-TX Fast Ethernet network requirements for the switches to operate at 100 Mbps.



Note: When using the fixed ports on the switch for 100 Mbps operation use Category 5 UTP cabling with an impedance between 85 and 111 ohms for 100 Mbps operation.

The fixed switch ports are capable of operating at 10, 100, or 1000 Mbps. This is accomplished by the switch when Auto-Negotiation is enabled. This enables the switch to automatically sense the transmission speed of the other device and adjust for the speed accordingly.

1000BASE-FX Network

The Mini-GBIC port sockets (21 through 24 on B2G124-24; 45 through 48 on B2G124-48; or 49 through 52 on B2H124-48) enable you to vary the type of 1-Gbps port connection. At the printing of this document there were five supported Mini-GBICs available, as follows:

- MGBIC-LC01 for a 1000BASE-SX compliant LC fiber-optic multimode connection
- MGBIC-LC03 for a 1000BASE-SX compliant LC fiber-optic multimode connection
- MGBIC-LC09 for a 1000BASE-LX compliant LC fiber-optic single-mode connection
- MGBIC-MT01 for a 1000BASE-SX compliant MT-RJ fiber-optic single-mode connection
- MGBIC-08 for a 1000BASE-ELX compliant LC fiber-optic single-mode connection

The device at the other end of the fiber connection must meet the same Gigabit Ethernet requirements for the connected devices to operate at 1-Gigabit speed.

1000BASE-T Network

The RJ45 fixed front panel connectors support RJ45 copper 1000BASE-T compliant connections. When connecting a 1000BASE-T segment to one of the RJ45 fixed ports use Category 5 UTP cabling. The device at the other end of the twisted pair segment must meet IEEE 802.3-2002 1000BASE-T Gigabit Ethernet network requirements for the devices to operate at 1000 Mbps.

Hardware Installation



Electrical Hazard: Only qualified personnel should perform installation procedures.

Riesgo Electrico: Solamente personal calificado debe realizar procedimientos de instalacion.

Elektrischer Gefahrenhinweis: Installationen sollten nur durch ausgebildetes und qualifiziertes Personal vorgenommen werden.

Important Notice

Read the Release Notes shipped with the switch to check for any exceptions to the supported features and operation documented in this guide.

This chapter provides instructions to install the B2G124-24, B2G124-48, and B2H124-48. Unless otherwise noted, the instructions apply to all switches. Follow the order of the sections listed below to correctly install the switch.

For information about...	Refer to page...
Considerations Prior to Installation	3-2
Required Tools	3-2
Unpacking the Switch	3-2
Installing Optional Mini-GBICs	3-3
Installing the Switch on a Flat Surface	3-6
Connecting High-Speed Stacking Cables	3-10
Configuring Switches in a Stack	3-12
Connecting AC and RPS-SYS Power	3-15
Connecting to Console Port for Local Management	3-18
Connecting to the Network	3-22
Completing the Installation	3-31

Considerations Prior to Installation

When installing the switch, note the following:

- Before starting the installation procedure, notify the network administrator of the installation.
- Follow the installation procedures in the order as presented in this guide.
- Do not connect the switch to the network until you have established the correct IP address.

Required Tools

A Phillips screwdriver is required to install the switch into a rack.

Unpacking the Switch

Unpack the switch as follows:

1. Open the box and remove the packing material protecting the switch.
2. Verify that the contents of the carton contains the items listed in [Table 3-1](#).

Table 3-1 Contents of Switch Carton

Item	Quantity
B2G124-24, B2G124-48, or B2H124-48 Switch	1
Mounting kit (two mounting brackets and eight M3x6-mm screws for rack mounting)	1
Rubber feet with adhesive backing for installation on a flat surface	4
AC power cord (The type of power cord is country dependent.)	1
This installation guide	1
Customer Release Notes	1
URL notice card	1

3. Remove the tape seal on the non-conductive bag to remove the switch.
4. Perform a visual inspection of the switch for any signs of physical damage. Contact Enterasys Networks if there are any signs of damage. Refer to [“Getting Help”](#) on page 1-8 for details.

Installing Optional Mini-GBICs

This section describes how to install Mini-GBICs in any of the SFP port slots (21 through 24 of B2G124-24; 45 through 48 of B2G124-48, or 49 through 52 for B2H124-48). It is recommended that the options be installed first in a new installation.



Warning: Fiber-optic Mini-GBICs use Class 1 lasers. Do not use optical instruments to view the laser output. The use of optical instruments to view laser output increases eye hazard. When viewing the output optical port, power must be removed from the network adapter.

Advertencia: Los Mini-GBICS de fibra optica usan lasers de clase 1. No se debe usar instrumentos opticos para ver la potencia laser. El uso de los instrumentos opticos para ver la potencia laser incrementa el riesgo a los ojos. Cuando vean el puerto de la potencia optica, la corriente debe ser removida del adaptador de la red.

Warnhinweis: Mini-GBICs mit Fiber-Optik Technologie benutzen Laser der Klasse 1. Benutzen sie keinesfalls optische Hilfsmittel, um die Funktion des Lasers zu überprüfen. Solche Hilfsmittel erhöhen die Gefahr von Sehschäden. Wenn sie den optischen Port überprüfen möchten stellen Sie sicher, dass die Komponente von der Spannungsversorgung getrennt ist.



Caution: Carefully follow the instructions in this manual to avoid damaging the Mini-GBIC and the device.

The Mini-GBIC and the device are sensitive to static discharges. Use an antistatic wrist strap and observe all static precautions during this procedure. Failure to do so could result in damage to the Mini-GBIC, Ethernet interface module, and DFE-Gold module. Always leave the Mini-GBIC in the antistatic bag or an equivalent antistatic container when not installed.

Precaución: Siga las instrucciones del manual para no dañar el Mini-GBIC ni del aparato, puesto que son muy sensible a las descargas de electricidad estática. Utilice la pulsera antiestática y tome todas las precauciones necesarias durante este procedimiento. Si no lo hace, podría dañar el Mini-GBIC o del aparato. Mientras no esté instalado, mantenga el Mini-GBIC en su bolsa antiestática o en cualquier otro recipiente antiestático.

Preparation

Before installing the Mini-GBIC, proceed as follows:

1. Before removing the Mini-GBIC from the antistatic packaging, it is recommended that you use an antistatic wrist strap (not supplied) to prevent damage from static discharge. To use the wrist strap, refer to the instructions provided with your antistatic wrist strap.
2. Remove the Mini-GBIC from its packaging.
3. If there is a protective dust cover (see 5 in [Figure 3-1](#) or [Figure 3-2](#)) in the Mini-GBIC connector, do not remove it at this time.

Installation

To install a Mini-GBIC that has an MT-RJ connector, refer to [Figure 3-1](#), or for a Mini-GBIC with an LC connector, refer to [Figure 3-2](#), and proceed as follows:

1. Hold the Mini-GBIC with the top side positioned as shown, and the 7-pin edge connector facing the port slot.
2. Align the Mini-GBIC with the port slot.
3. Push the Mini-GBIC into the port slot until the Mini-GBIC “clicks” and locks into place.

Figure 3-1 Mini-GBIC with MT-RJ Connector

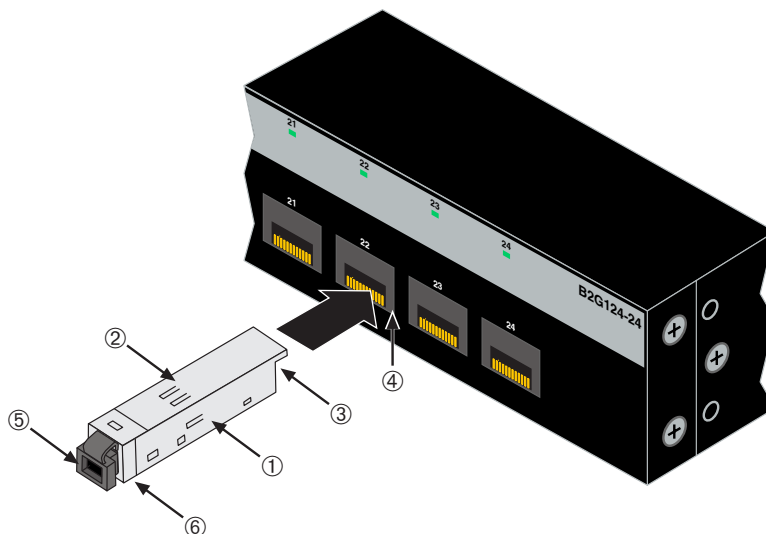

- | | |
|---|-------------------------|
| 1 Mini-GBIC (MGBIC-MT01) | 4 Port slot |
| 2 Mini-GBIC, top side | 5 Protective dust cover |
| 3 7-pin edge connector (insertion side) | 6 Release tab |

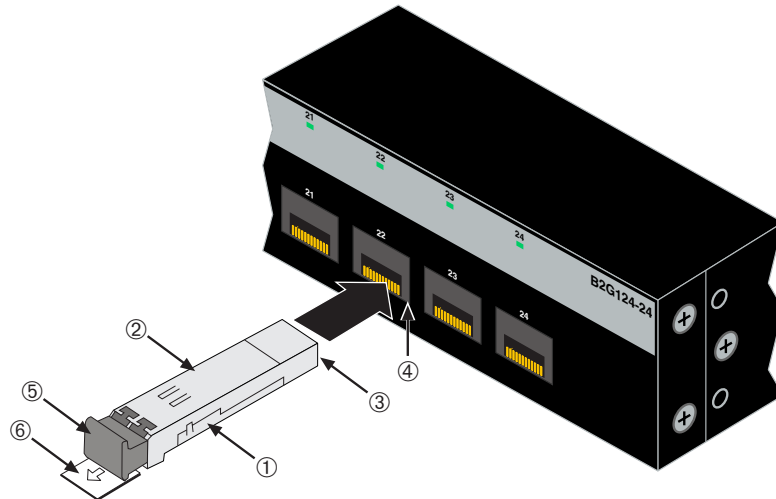
Figure 3-2 Mini-GBIC with LC Connector

- | | |
|---|-------------------------|
| 1 Mini-GBIC (MGBIC-LC01 or MGBIC-LC09) | 4 Port slot |
| 2 Mini-GBIC, top side | 5 Protective dust cover |
| 3 7-pin edge connector (insertion side) | 6 Release tab |

Removing the Mini-GBIC



Caution: Do NOT remove a Mini-GBIC from a slot without releasing the locking tab located under the front bottom end of the Mini-GBIC. This can damage the Mini-GBIC.

The Mini-GBIC and its host switch are sensitive to static discharges. Use an antistatic wrist strap and observe all static precautions during this procedure. Failure to do so could result in damaging the Mini-GBIC or host switch. Always leave the Mini-GBIC in the antistatic bag or an equivalent antistatic container when not installed.

Precaución: NO quite el Mini-GBIC de la ranura sin antes abrir la traba ubicada en la parte frontal del Mini-GBIC.

Si lo hace, puede dañar el Mini-GBIC, puesto que es muy sensible a las descargas de electricidad estática, al igual que el dispositivo host. Utilice la pulsera antiestática y tome todas las precauciones necesarias durante este procedimiento. Si no lo hace, puede dañar el Mini-GBIC o el dispositivo host. Mientras no esté instalado, mantenga el Mini-GBIC en su bolsa antiestática o en cualquier otro recipiente antiestático.

To remove a Mini-GBIC from a port slot, refer back to [Figure 3-1](#) and [Figure 3-2](#), and proceed as follows:

1. Attach your antistatic wrist strap (refer to the instructions in your antistatic wrist strap package) before removing the Mini-GBIC.
2. Remove the cables connected to the Mini-GBIC.

3. Locate the release tab under the front end of the Mini-GBIC. For the type of Mini-GBIC shown in [Figure 3-1](#), push in on the release tab as far as it will go to release the Mini-GBIC from the port slot. For the type of Mini-GBIC shown in [Figure 3-2](#), pull out on the release tab to release the Mini-GBIC from the port slot.
4. Grasp the sides of the Mini-GBIC and pull it straight out of the port slot.

If storing or shipping a Mini-GBIC, which has a fiber-optic connector, insert its protective dust cover to protect the ends of the fiber-optic fibers from dust or contamination.

Installing the Switch on a Flat Surface

When installing the switch on a flat surface, the installation of the rubber feet is recommended to prevent the switch from sliding on a flat surface. Installing the rubber feet is optional if you are installing the switch in a rack. To install the rubber feet, proceed to “[Installing the Rubber Feet](#)” instructions below. For instructions to rack mount the switch, proceed to “[Rack Mounting the Switch](#)” on page 3-9.

Installing the Rubber Feet

To install the rubber feet, refer to [Figure 3-3](#) and proceed as follows:

1. Place the switch on its back on a sturdy flat surface to gain access to the bottom of the chassis.
2. Remove the four rubber feet from their plastic bag in the shipping box.
3. Locate the four marked locations on the bottom four corners of the chassis.

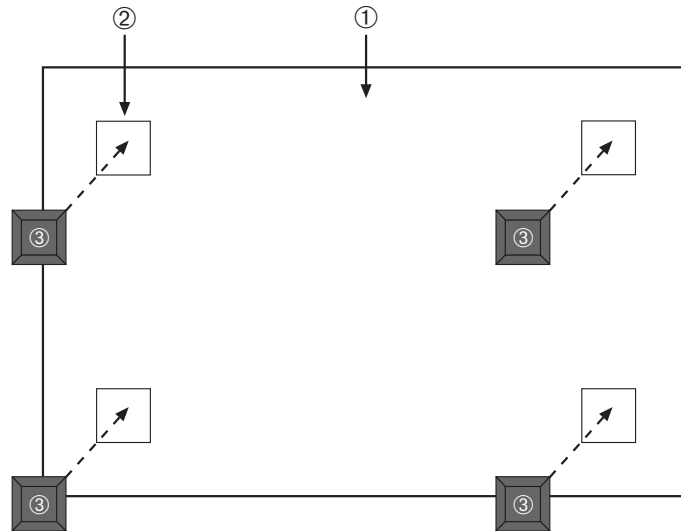
Figure 3-3 Chassis Bottom, Rubber Feet Placement

- 1 Bottom of chassis as seen when chassis is resting on its back
- 2 Locations to install the rubber feet (four locations)
- 3 Rubber feet with adhesive backing (four)

4. Remove the protective strip from the back of one rubber foot and position it on a marked location and press firmly into place. Repeat this procedure to install the remaining three rubber feet in the other three locations.
5. After installing the rubber feet, return the switch to its upright position.



Note: If a number of switches are being installed in a stack, repeat steps 1 through 4 to install the rubber feet on each switch before continuing with the installation.

6. Proceed to “[Guidelines for Flat Surface Installation](#)” on page 3-8. For a rackmount installation, proceed to “[Rack Mounting the Switch](#)” on page 3-9.

Guidelines for Flat Surface Installation

Locate the switch within 152 cm (5 ft) of its power source and on a surface as shown in [Figure 3-4](#). If an optional redundant power system is going to be installed and connected to the 14-pin Redundant Power Supply input connector on the rear of the switch, refer to the installation guide shipped with the redundant power system.



Caution: To ensure proper ventilation and prevent overheating, leave a minimum clearance space of 5.1 cm (2.0 in.) at the left, right, and rear of the switch.

Do not connect the switch to the AC power source until instructed to do so later in the installation process.

Precaución: Para asegurar una buena ventilación y evitar que el sistema se sobrecaliente, deje un espacio mínimo de 5.1 cm (2 pulgadas) con respecto a los lados y a la parte posterior del aparato.

No conecte el dispositivo a la fuente primaria hasta que no se le indique.

If you are installing several switches in a stack, proceed to “[Connecting High-Speed Stacking Cables](#)” on page 3-10. If the switch is being installed as a standalone switch, proceed to “[Connecting AC and RPS-SYS Power](#)” on page 3-15 for power connection instructions.

Figure 3-4 Area Guidelines for Switch Installation on Flat Surface

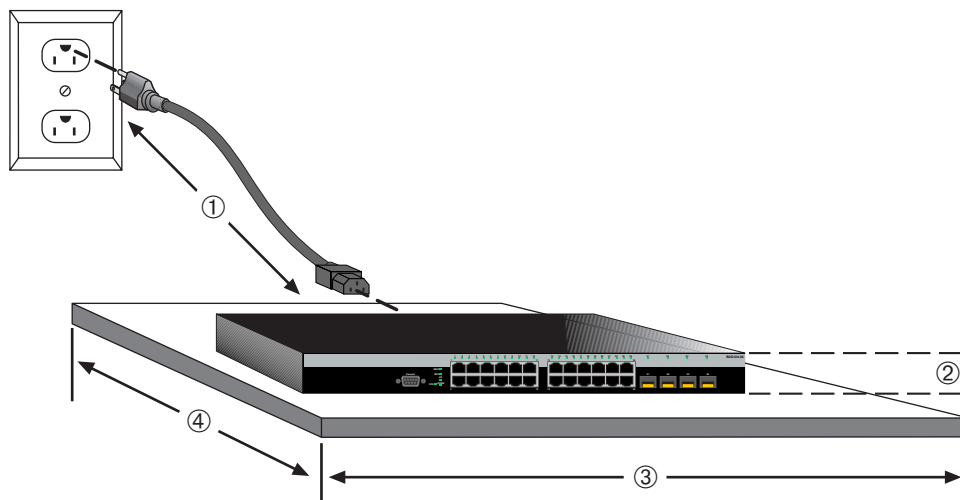

- | | | | |
|---|--|---|---|
| 1 | Approximately 152 cm (5 ft) from power source | 3 | 44.5 cm (19.4 in.) for proper ventilation |
| 2 | 4.45 cm (1.75 in.) per switch. (Vertical clearance depends on number of switches stacked.) | 4 | 41.9 cm (16.5 in.) for proper ventilation |

Rack Mounting the Switch

To install the switch in a 19-inch rack, you need:

- Two rackmount brackets and mounting screws (rackmount kit) shipped with the switch.
- Four user-supplied screws to attach the switch to a standard 19-inch rack.

Guidelines for Rackmount Installation

The installation site must be within reach of the network cabling and meet the requirements listed below:

- Appropriate grounded power receptacles must be located within 152 cm (5 ft) of the location.
- A temperature of between 5°C (41°F) and 40°C (104°F) must be maintained at the installation site with fluctuations of less than 10°C (18°F) per hour.



Note: To ensure proper ventilation and prevent overheating, leave a minimum clearance space of 5.1 cm (2.0 in.) at the left, right, and rear of the switch.



Warning: Before rack-mounting the switch, ensure that the rack can support it without compromising stability. Otherwise, personal injury and/or equipment damage may result.

Advertencia: Antes de montar el equipo en el rack, asegurarse que el rack puede soportar su peso sin comprometer su propia estabilidad, de otra forma, daño personal o del equipo puede ocurrir.

Warnhinweis: Überzeugen Sie sich vor dem Einbau des Gerätes in das Rack von dessen Stabilität, ansonsten könnten Personenschäden oder Schäden am Gerät die Folge sein.

Attaching Brackets and Installing in Rack

Proceed as follows to install the switch into a 19-inch rack:

1. Attach the rackmount brackets to the switch, as shown in [Figure 3-5](#), using the eight M3x6 mm flathead screws shipped with the switch.

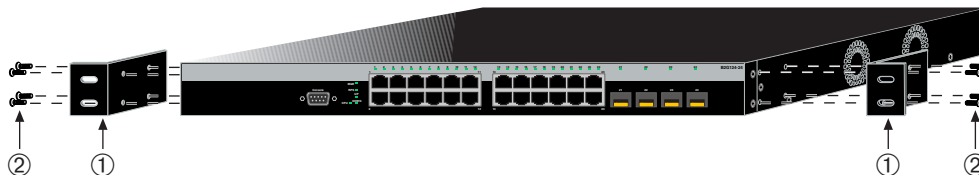
Figure 3-5 Attaching the Rackmount Brackets

1 Rackmount brackets

2 M3x6 mm flathead screws

2. With the mounting brackets attached, position the switch between the vertical frame members of the 19-inch rack as shown in [Figure 3-6](#). Then fasten the switch securely to the frame using four mounting screws (user supplied).

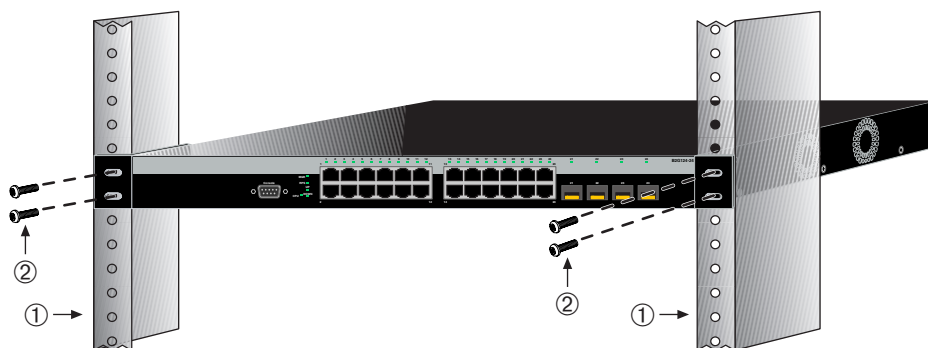
Figure 3-6 Fastening the Switch to the Rack

1 Rails of 19-inch rack

2 Mounting screws (supplied by user)

3. If you are installing this switch in a stacked configuration, repeat this procedure for each switch until all switches have been installed in the stack, then proceed to [“Connecting High-Speed Stacking Cables”](#) on page 3-10. Otherwise, proceed to [“Connecting AC and RPS-SYS Power”](#) on page 3-15.

Connecting High-Speed Stacking Cables

The stack of switches can be connected in a ring or daisy chain topology. In a ring topology all the switches are connected. The only difference in the cable connections in a daisy chain topology is that one cable is not installed. Up to seven or eight switches can be stacked together and connected by high-speed stacking cables. You can add switches and reach up to a maximum of 384 Ethernet ports per stack. The high-speed stacking cables allow the entire stack to operate with a single IP address.

The high-speed stacking cables are optional items and must be ordered separately. The B2G124-48 and B2H124-48 support three types of SecureStack stacking cables:

- C2CAB-SHORT cable to connect two adjacent switches in the stack. If the stack is in a configuration where the adjacent switches are too far apart for the SHORT cables, the LONG cable can be used for the connections.
- C2CAB-LONG cable to connect from the top switch to the bottom switch in the stack. You need only one C2CAB-LONG cable per stack.
- C2CAB-5M cable to connect from the top switch to the bottom switch in the stack when these two switches are physically located in separate mounting racks and require a longer cable reach.



Note: The B2G124-24 supports only the C2CAB-SHORT and C2CAB-LONG stacking cables.

Figure 3-7 shows an example of a four-high stack connected in a ring topology. All STACK DOWN and STACK UP connectors are used in the installation. The high-speed stacking cable connections are from the STACK DOWN connector of one switch to the STACK UP connector of the next switch up in the stack. A high-speed stacking cable connection from the STACK DOWN connector of the switch at the top of the stack to the STACK UP connector at the bottom of the stack completes the ring connection. In a daisy chain topology, one cable connection is not made.

Figure 3-7 High-Speed Stacking Cable Connections

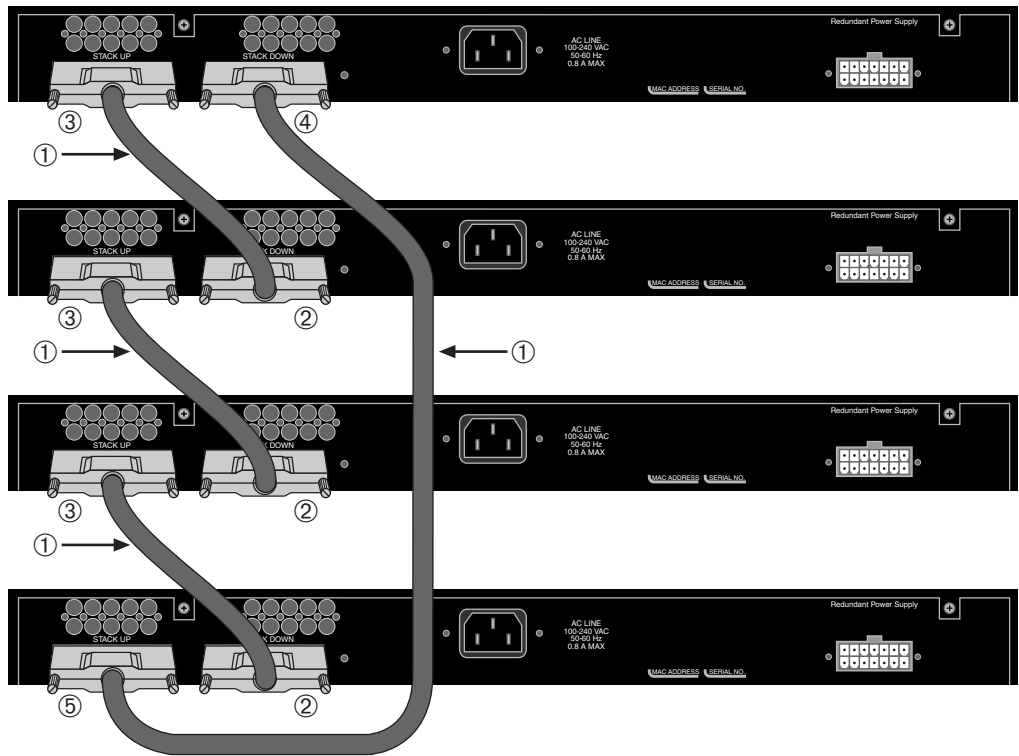

- | | |
|-----------------------------|---|
| 1 High-speed stacking cable | 4 STACK DOWN connector at top of stack |
| 2 STACK DOWN connector | 5 STACK UP connector at bottom of stack |
| 3 STACK UP connector | |

After connecting the cables to the stacking ports, proceed to [“Configuring Switches in a Stack”](#) on page 3-12 for instructions.

Configuring Switches in a Stack

The information in the following sections is important to understand B2 switch operation and installations in a stack installation.

About SecureStack B2 Switch Operation in a Stack

The SecureStack B2 products are stackable switches that can be adapted and scaled to help meet your network needs. These switches provide a management platform and uplink to a network backbone for a stacked group of up to eight B2 switches.

Once installed in a stack, the switches behave and perform as a single switch. As such, you can start with a single switch and add more switches as your network expands. You can also mix different products in the family in a single stack to provide a desired combination of port types and functions to match the requirements of individual applications. In all cases, a stack of switches performs as one large product, and is managed as a single network entity.

When switches are installed and connected as described back in [“Connecting High-Speed Stacking Cables”](#) on page 3-10, the following occurs during initialization:

- The switch that will manage the stack is automatically established and is referred to as the Manager switch.
- All other switches are established as Member switches in the stack.
- The hierarchy of the switches that will assume the function of backup manager is also determined in case the current manager malfunctions, is powered down, or is disconnected from the stack.
- The Console port on the manager switch remains active for out-of-band (local) switch management, but the Console port on each member switch is deactivated. This enables you to set the IP address and system password using a single Console port. Now each switch can be configured locally using only the manager’s Console port, or in-band using a remote device and the CLI set of commands described in this section. For procedures used for various types of connections to the Console port, refer to [“Connecting to Console Port for Local Management”](#) on page 3-18.

Once a stack is created (more than one switch is interconnected), the following occurs:

1. Switch (unit) IDs are arbitrarily assigned on a first-come, first-served basis.
2. Switch IDs are saved against each module. Then, every time a board is power-cycled, it will initialize with the same switch ID. This is important for port-specific information (for example: ge.4.12 is the 12th Gigabit Ethernet port on switch number 4).
3. The management election process uses the following precedence to assign a management switch:
 - a. Previously assigned/elected management switch
 - b. Management assigned priority (values 1–15)
 - c. Hardware preference level
 - d. Highest MAC Address

Recommended Procedures for New and Existing Stacks

Important

The following procedures assume that all switches have a clean configuration from manufacturing. When adding a new switch to an already running stack, it is also assumed that the new switch is using the same firmware image version as other switches in the stack.

Installing a New Stackable System of Up to Eight Switches

Use the following procedure to install a new stack of up to eight switches out of the box. Before applying power, make **all** physical connections with the stack cables as described in [“Connecting High-Speed Stacking Cables”](#) on page 3-10.

1. Once all of the stack cables have been connected, individually power on each switch from top to bottom (connecting power to a switch is described in [“Connecting AC and RPS-SYS Power”](#) on page 3-15).

If the switches are powered on almost simultaneously, the system will automatically select the first one that powers up as the Master switch and the others as Member switches. The switches are assigned unit IDs in the order that they become fully operational.

You can control the unit ID assignment according to the physical position in a stack. When you power up each switch and allow it to become fully operational before applying power to the next switch, the first one becomes the Manager and all the next switches will join that stack (regardless of Priority, Firmware Revision, or MAC Address). The switches are assigned unit IDs in the order that you power on each switch.



Note: Once switch IDs are assigned, they are persistent and will be retained during a power cycle to any or all of the switches.

2. (Optional) If desired, change the management switch using the **set switch movemanagement** command as described in the *SecureStack B2 Configuration Guide*.
3. Once the desired master switch has been selected, reset the system using the **reset** command as described in the *SecureStack B2 Configuration Guide*.

Adding a New Switch to an Existing Stack

Use the following procedure to install a new switch to an existing stack configuration. This procedure assumes that the new switch being added has a clean configuration from manufacturing and is running the same firmware image version as other switches in the stack.

1. Ensure that power is off on the new switch being installed.
2. Use one of the following methods to complete the stack cable connections:
 - If the running stack uses a daisy chain topology, make the stack cable connections from the bottom of the stack to the new switch (that is, STACK DOWN port from the bottom switch of the running stack to the STACK UP port on the new switch).
 - If the running stack uses a ring stack topology, break the ring and make the stack cable connections to the new switch to close the ring.
3. Apply power to the new switch.

Important Considerations About Using Clear Config in a Stack

When using the **clear config** command (as described in the *SecureStack B2 Configuration Guide*) to clear configuration parameters in a stack, it is important to remember the following:

- Use **clear config** to clear config parameters without clearing stack switch IDs. This command WILL NOT clear stack parameters and avoids the process of re-numbering the stack.
 - Use **clear config all** when it is necessary to clear all config parameters, including stack switch IDs and switch priority values.
-

Connecting AC and RPS-SYS Power

AC Power



Note: The power supply in the switch has automatic voltage sensing that allows connection to power sources ranging from 100 to 240 VAC.

To connect a switch to the AC power source, refer to [Figure 3-8](#) and proceed as follows:

1. Plug the power cord into the switch AC power connector.
2. Plug the other end of the power cord into a dedicated grounded AC outlet (not shown). The type of power outlet and power cord are country-dependent.



Note: If you plan to connect all the switches quickly to allow automatic Manager selection, wait until all switches are fully operational before proceeding to the next step.

If you plan to power up each switch and allow it to become fully operational before applying power to the next switch, proceed to the next step.

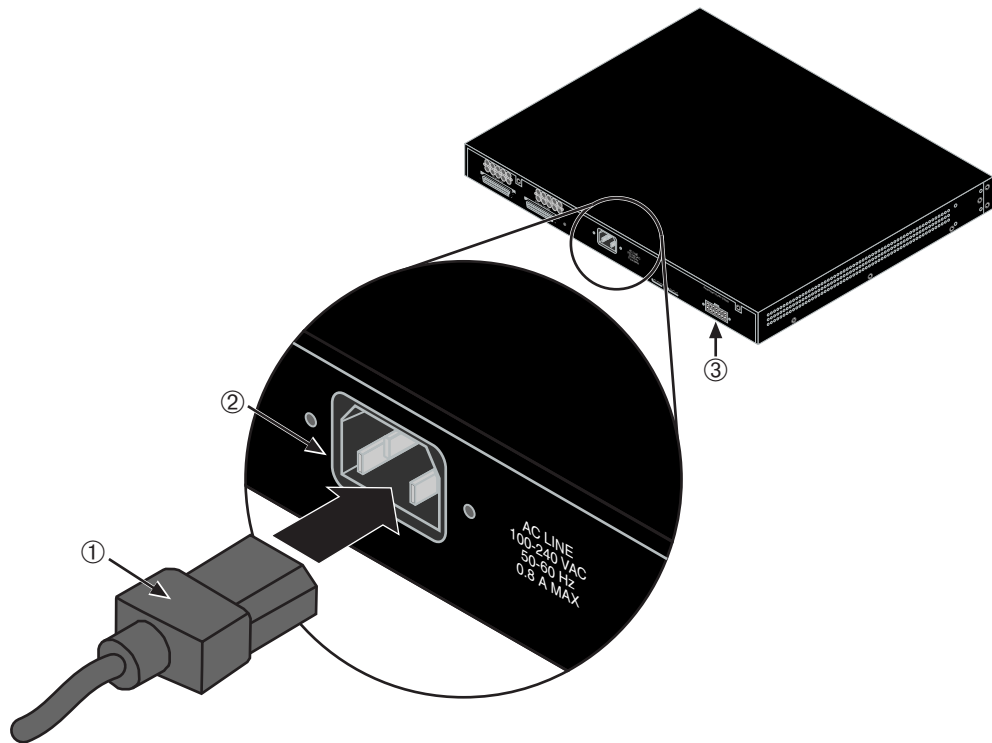
Figure 3-8 Switch Rear View

1 AC power cord **2** AC power connector **3** Connector for external redundant power supply

3. Observe that the power CPU LED (not shown), located on the front panel. During the initialization, the CPU LED will start by illuminating solid amber, then start blinking green, then blinking amber, then blinking green again until the end of the initialization, and then turns solid green.



Note: If the CPU LED illuminates solid red, there was a critical failure. For more information about the LED indications and troubleshooting, refer to [Chapter 4](#). If you need additional help, contact Enterasys Networks. Refer to “[Getting Help](#)” on page 1-8 for details.

If the switch is a standalone switch, it will take approximately 30 seconds for the switch to start up. If the switch is a stack Manager, it can take up to 3 minutes or more to start up, depending on the number of Member switches in the stack.

C2RPS-SYS Redundant Power System

If you are installing an optional redundant power system (C2RPS-SYS), refer to the installation instructions supplied with the SecureStack RPS. The switch is connected to a C2RPS-PSM using a C2RPS-PSM Cable.



Caution: To prevent damaging the switch, DO NOT connect a Power over Ethernet-compliant Redundant Power System (C2RPS-POE) to the redundant power supply connector. The switch is only compatible with the SecureStack C2RPS-SYS redundant power supply system.

Precaución: No conecte una fuente de poder redundante (RPS) SecureStack C2 PoE (C2RPS-POE) al cable de corriente. De lo contrario, el dispositivo puede dañarse.

If you are installing the switch as a standalone switch, proceed to [“Connecting to Console Port for Local Management”](#) on page 3-18. If you are installing switches in a stack configuration, apply power to each switch in order, according to the procedure you use in [“Configuring Switches in a Stack”](#) on page 3-12.

Stack Initialization Overview

When you install and connect all the high-speed stacking cables to the switches in the stack before applying power to the switches, the following occurs:

- The switch that will manage (Manager) the stack is automatically established with all other switches established as Member switches in the stack. When the switches complete their initializations, one of the switches in the stack will illuminate its Manager LED, indicating that it is the stack Manager. The Manager LED on each Member switch will be off.
- The hierarchy of the switches that will function as backup Manager is also determined in case the current Manager malfunctions, is powered down, or is disconnected from the stack.
- The Console port on each Member switch is deactivated. Only the Console port on the Manager switch is active for out-of band configuration to set the IP address, password, and other configuration settings.

Once you know which switch is the Manager, proceed to [“Connecting to Console Port for Local Management”](#) on page 3-18.

Connecting to Console Port for Local Management

This section describes how to install an RS232 DTE interface cable to a PC, a VT series terminal, or a modem to a SecureStack B2G124-24, B2G124-48, or B2H124-48 for out-of-band sessions using CLI commands.



Note: When switches are connected in a stack configuration and all high-speed stacking cables are connected before powering up the switches, one switch in the stack will be automatically designated as the Manager of the stack and its Console port will remain active. All other switches will become Member switches and their Console ports will be deactivated.

What Is Needed

The following is a list of user-supplied DTE interface cables that may be needed to connect the DB9 male Console port connector on the switch. The cables are terminated by a DB9 female connector at one end, and by one of three type connectors at the other end, depending on the type connection needed for the remote device. The cables that may be needed are as follows:

- DB9 female-to-DB9 female
- DB9 female-to-DB25 female
- DB9 female-to-DB25 male

Using a DTE modem DB9 female-to-DB9 female cable, you can connect products equipped with a DB9 DTE male console port to an IBM or compatible PC running a VT series emulation software package.

Using a DTE modem DB9 female-to-DB25 female cable, you can connect products equipped with a DB9 DTE male console port to a VT series terminal or VT type terminals running emulation programs for the VT series.

Using a DTE modem DB9 female-to-DB25 male cable, you can connect products equipped with a DB9 DTE male console port to a Hayes compatible modem that supports 9600 baud.

The cable used must connect the Console port Received Data, Pin 2 to the Transmitted Data pin at the other end of the cable. The connection from the Console port Transmitted Data, Pin 3 (must be connected) to the Received Data pin cable connection at the other end of the cable. The DB9 Console port pin assignments are shown in [Figure 3-9](#).

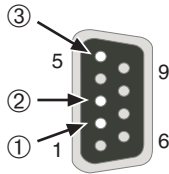
Figure 3-9 DB9 Male Console Port Pinout Assignments

- 1 Pin 2, Received Data (input)
 - 2 Pin 3, Transmitted Data (output)
 - 3 Pin 5, Signal Ground
- All other pins not connected.

Connecting to an IBM or Compatible Device

To connect an IBM PC or compatible device, running the VT terminal emulation, to an Enterasys switch Console port (Figure 3-10), proceed as follows:

1. Connect the DB9 female connector at one end of the cable (not supplied) to the Console port on the Enterasys switch. (If there is a switch designated as the Manager, connect to its Console port.)
2. Plug the DB9 female connector at the other end of cable into the communications port on the PC.
3. Turn on the PC and configure your VT emulation package with the following parameters:

Parameter	Setting
Mode	7 Bit Control
Transmit	Transmit=9600
Bits Parity	8 Bits, No Parity
Stop Bit	1 Stop Bit

When these parameters are set, the Startup screen will display. Proceed to [“Connecting to the Network”](#) on page 3-22.

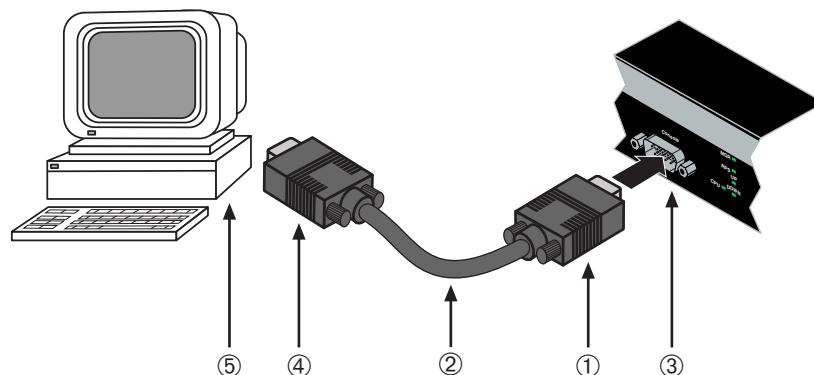
Figure 3-10 Connecting an IBM PC or Compatible

- | | |
|-----------------------------------|------------------------------------|
| 1 DB9 female connector | 4 DB9 female connector |
| 2 Serial interface cable | 5 PC with VT emulation application |
| 3 DB9 male Console port connector | |

Connecting to a VT Series Terminal

To connect a VT Series terminal to an Enterasys switch Console port (Figure 3-11), use a UTP serial interface cable terminated with a DB9 female connector and a DB25 female connector and proceed as follows:

1. Connect the DB9 female connector at one end of cable to the Console port DB9 male connector on the Enterasys switch. (If there is a switch designated as the Manager, connect to its Console port.)
2. Plug the DB25 female connector at the other end of the cable into the port labeled COMM on the VT terminal.
3. Turn on the terminal and access the Setup Directory. Set the following parameters on your terminal:

Parameter	Setting
Mode	7 Bit Control
Transmit	Transmit=9600
Bits Parity	8 Bits, No Parity
Stop Bit	1 Stop Bit

When these parameters are set, the Startup screen will display. Proceed to [“Connecting to the Network”](#) on page 3-22.

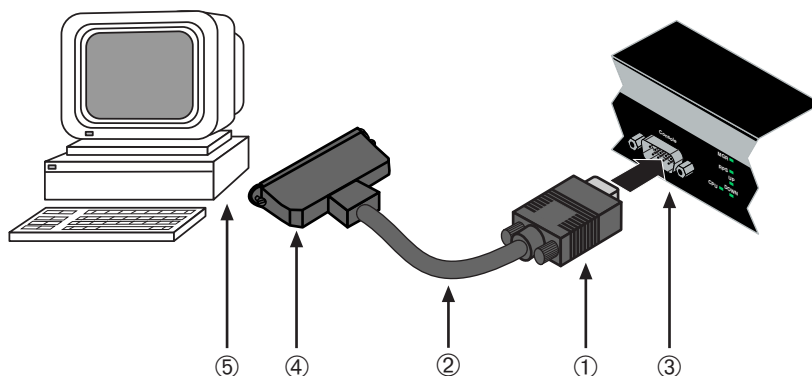
Figure 3-11 Connecting a VT Series Terminal

- | | |
|-----------------------------------|------------------------------------|
| 1 DB9 female connector | 4 DB25 female connector |
| 2 Serial interface cable | 5 PC with VT emulation application |
| 3 DB9 male Console port connector | |

Connecting to a Modem

To connect a modem to an Enterasys Networks switch modem port ([Figure 3-12](#)), use a UTP cable terminated with a DB9 female connector and a DB25 male connector, and proceed as follows:

1. Connect the DB9 female connector at one end of the cable to the Console port DB9 connector on the Enterasys switch. (If there is a switch designated as the Manager, connect to its Console port.)
2. Plug the DB25 male connector at the other end of the cable into the modem communications port.
3. Turn on the modem and make sure the remote modem is ON.
4. With your PC connected to the remote modem, configure your VT emulation package with the following parameters:

Parameter	Setting
Mode	7 Bit Control
Transmit	Transmit=9600
Bits Parity	8 Bits, No Parity
Stop Bit	1 Stop Bit

When these parameters are set, the Startup screen will display. If the switches are in a stacked configuration, proceed to [“Connecting to the Network”](#) on page 3-22.

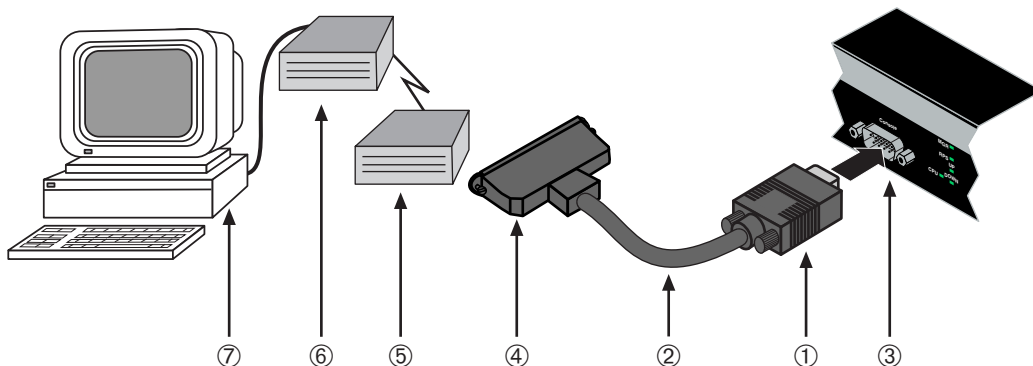
Figure 3-12 Connecting to a Modem

- | | | |
|------------------------------|-----------------------|------------------------------------|
| 1 DB9 female cable connector | 4 DB25 male connector | 7 PC with VT emulation application |
| 2 Serial interface cable | 5 Local modem | |
| 3 DB9 male Console port | 6 Remote modem | |

Connecting to the Network

The following procedures cover the cable connections from the network or other devices to the switch RJ45 ports or any installed optional Mini-GBIC.

- [Connecting UTP Cables](#) on page 3-22
- [Connecting Fiber-Optic Cables to MT-RJ Ports](#) on page 3-26
- [Connecting Fiber-Optic Cables to LC Ports](#) on page 3-28

Connecting UTP Cables

The fixed RJ45 front panel ports are 10/100/1000 Mbps ports and have internal crossovers. When connecting a workstation to these ports, use a straight-through cable. When connecting networking devices to these ports, such as a bridge, repeater, or router, use a crossover cable.



Note: All fixed RJ45 front panel ports support Category 5 Unshielded Twisted Pair (UTP) cabling with an impedance between 85 and 111 ohms. Category 3 cable may be used if the connection is going to be used only for 10 Mbps.

To connect twisted pair segments to the switch, refer to [Figure 3-13](#) and proceed as follows:

1. Ensure that the device to be connected at the other end of the segment is powered ON.

2. Connect the twisted pair segment to the switch by inserting the RJ45 connector on the twisted pair segment into the desired RJ45 port (for example, Port 8).

Figure 3-13 Connecting a UTP Cable Segment to RJ45 Port

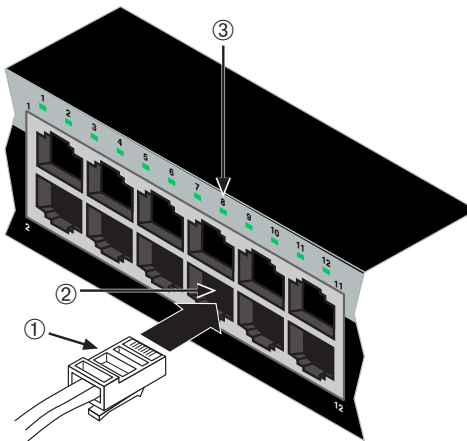

- 1 RJ45 connector
- 2 Port 8

- 3 Port 8 Link/Activity LED

3. Verify that a link exists by checking that the Link/Activity LED is ON (solid green or blinking green). If the Link/Activity LED is OFF, perform the following steps until it is on:
 - a. Verify that the cabling being used is Category 5 or better with an impedance between 85 and 111 ohms with a maximum length of 100 meters (328 feet).
 - b. Verify that the device at the other end of the twisted pair segment is on and properly connected to the segment.
 - c. Verify that the RJ45 connectors on the twisted pair segment have the proper pinouts and check the cable for continuity. Typically, a crossover cable is used between hub devices. A straight-through cable is used to connect between switches or hub devices and an end user (computer). Refer to [Figure 3-14](#) and [Figure 3-15](#) for four-wire RJ45 connections. Refer to [Figure 3-16](#) and [Figure 3-17](#) for eight-wire RJ45 connections.
 - d. Ensure that the twisted pair connection meets the dB loss and cable specifications outlined in the *Cabling Guide*. Refer to “[Related Documents](#)” on page xvi for information on obtaining this document.
4. If a link is not established, contact Enterasys Networks. Refer to “[Getting Help](#)” on page 1-8 for details.

Repeat all steps above until all connections have been made.

Figure 3-14 Four-Wire Crossover Cable RJ45 Pinouts for 10/100BASE-TX

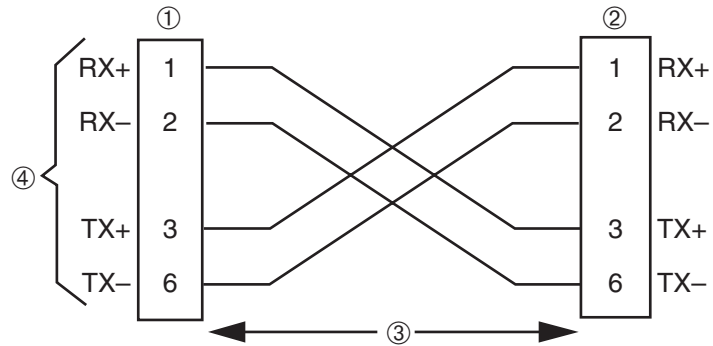

- 1 RJ45 switch port
- 2 Other device port

- 3 RJ45-to-RJ45 crossover cable
- 4 RX+/RX- and TX+/TX-connections
These connections must share a common color pair.

Figure 3-15 Four-Wire Straight-Through Cable RJ45 Pinouts for 10/100BASE-TX

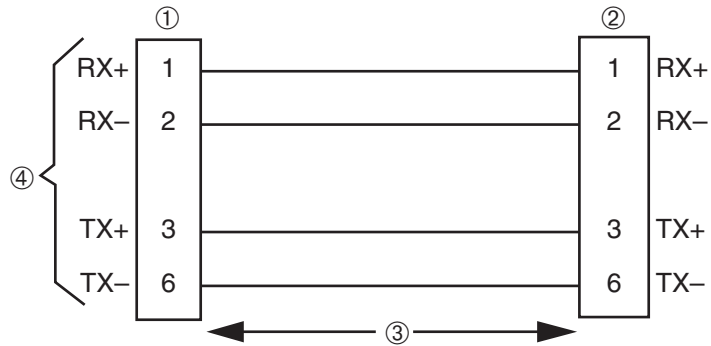

- 1 RJ45 switch port
- 2 Other device port

- 3 RJ45-to-RJ45 straight-through cable
- 4 RX+/RX- and TX+/TX-connections
These connections must share a common color pair.

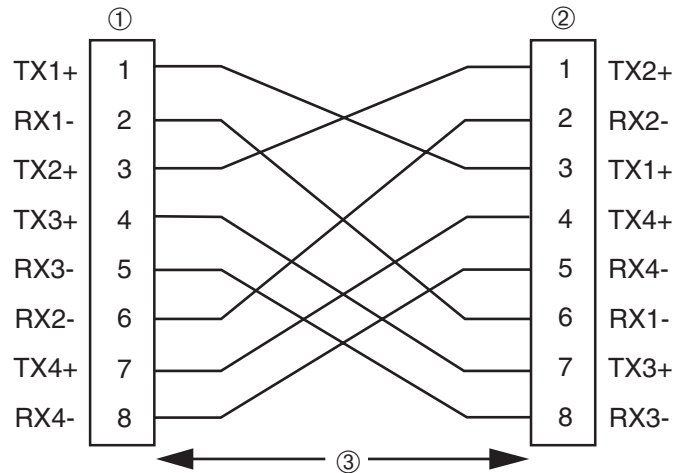
Figure 3-16 Eight-Wire Crossover Cable RJ45 Pinouts for 10/100/1000BASE-TX

1 RJ45 device port

3 RJ45-to-RJ45 crossover cable

2 Other device port

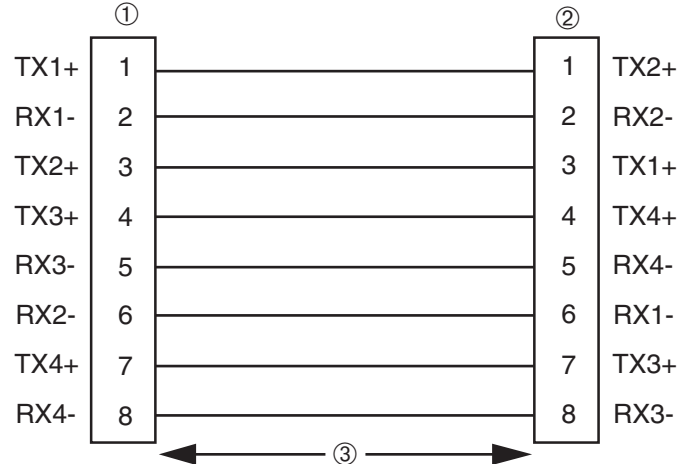
Figure 3-17 Eight-Wire Straight-Through Cable RJ45 Pinouts for 10/100/1000BASE-TX

1 RJ45 device port

3 RJ45-to-RJ45 straight-through cable

2 Other device port

Connecting Fiber-Optic Cables to MT-RJ Ports



Warning: Fiber-optic Mini-GBICs use Class 1 lasers. Do not use optical instruments to view the laser output. The use of optical instruments to view laser output increases eye hazard. When viewing the output optical port, power must be removed from the network adapter.

Advertencia: Los Mini-GBICS de fibra optica usan lasers de clase 1. No se debe usar instrumentos opticos para ver la potencia laser. El uso de los instrumentos opticos para ver la potencia laser incrementa el riesgo a los ojos. Cuando vean el puerto de la potencia optica, la corriente debe ser removida del adaptador de la red.

Warnhinweis: Mini-GBICs mit Fiber-Optik Technologie benutzen Laser der Klasse 1. Benutzen sie keinesfalls optische Hilfsmittel, um die Funktion des Lasers zu überprüfen. Solche Hilfsmittel erhöhen die Gefahr von Sehschäden. Wenn sie den optischen Port überprüfen möchten stellen Sie sicher, dass die Komponente von der Spannungsversorgung getrennt ist.

This section contains the procedures for connecting a 1000BASE-SX multimode fiber-optic segment from the network or other devices to an MT-RJ port connector in a Mini-GBIC (MGBIC-MT01).

Each fiber-optic link consists of two fiber-optic strands within the cable:

- Transmit (TX)
- Receive (RX)

The transmit strand from a switch port connects to the receive port of a fiber-optic Gigabit Ethernet device at the other end of the segment. The receive strand of the applicable MT-RJ port connects to the transmit port of the fiber-optic Gigabit Ethernet switch.

Enterasys Networks recommends labeling fiber-optic cables to indicate receive and transmit ends. Many cables are pre-labeled, providing matching labels or tapes at both ends of each strand of cable.

To connect an MT-RJ cable to a fixed MT-RJ connector of a Mini-GBIC, refer to [Figure 3-18](#) and proceed as follows:

1. Remove the protective covers (not shown) from the front panel MT-RJ fiber-optic port (port 22 in this example) and from the connectors on each end of the cable.



Note: Leave the protective covers in place when the connectors are not in use to prevent contamination.



Caution: Do not touch the ends of the fiber-optic strands, and do not let the ends come in contact with dust, dirt, or other contaminants. Contamination of cable ends causes problems in data transmissions. If the ends of the fiber-optic strands become contaminated, use a canned duster to blow the surfaces clean. A fiber-port cleaning swab saturated with optical-grade isopropyl alcohol may also be used to clean the ends.

Precaución: No toque los extremos de los cables de fibra óptica y evite su contacto con el polvo, la suciedad o con cualquier otro contaminante. Si los extremos de los cables se ensucian, es posible que la transmisión de datos se vea afectada. Si nota que los extremos de los cables de fibra óptica se ensucian, utilice aire comprimido para limpiarlos. También puede limpiarlos con un estropajo embebido en alcohol isopropílico.

2. Insert the MT-RJ cable connector into the MT-RJ connector until it clicks into place.



Note: To remove the MT-RJ cable connector, press on its release tab and pull out the cable connector.

Figure 3-18 Cable Connection to MT-RJ Multimode Fiber-Optic Connectors

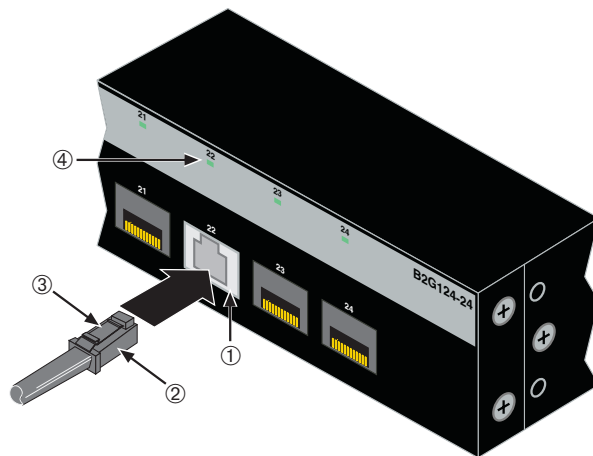

- | | |
|----------------------------------|---------------------|
| 1 Mini-GBIC MT-RJ port connector | 3 Release tab |
| 2 MT-RJ cable connector | 4 Link/Activity LED |

3. Plug the other end of the cable into the appropriate port on the other device. Some cables may be terminated at the other end with two separate connectors, one for each fiber-optic strand. In this case, ensure that the transmit fiber-optic strand is connected to the receive port and the receive fiber-optic strand to the transmit port.
4. Verify that a link exists by checking that the port Link/Activity LED is on (blinking green or solid green). If the Link/Activity LED is off, perform the following steps until it is on:
 - a. Verify that the device at the other end of the segment is ON and connected to the segment.

- b. If there are separate fiber-optic connections on the other device, check the crossover of the cables. Swap the cable connections if necessary.
- c. Check that the fiber-optic connection meets the dB loss and cable specifications outlined in the *Cabling Guide* for multimode cabling. To obtain this document, refer to “[Related Documents](#)” on page xvi.

If a link has not been established, refer to [Chapter 4](#) for LED troubleshooting details. If a problem persists, refer to “[Getting Help](#)” on page 1-8 for details on contacting Enterasys Networks for support.

5. Repeat steps 1 through 4, above, until all connections have been made.

Connecting Fiber-Optic Cables to LC Ports



Warning: Fiber-optic Mini-GBICs use Class 1 lasers. Do not use optical instruments to view the laser output. The use of optical instruments to view laser output increases eye hazard. When viewing the output optical port, power must be removed from the network adapter.

Advertencia: Los Mini-GBICS de fibra optica usan lasers de clase 1. No se debe usar instrumentos opticos para ver la potencia laser. El uso de los instrumentos opticos para ver la potencia laser incrementa el riesgo a los ojos. Cuando vean el puerto de la potencia optica, la corriente debe ser removida del adaptador de la red.

Warnhinweis: Mini-GBICs mit Fiber-Optik Technologie benutzen Laser der Klasse 1. Benutzen sie keinesfalls optische Hilfsmittel, um die Funktion des Lasers zu überprüfen. Solche Hilfsmittel erhöhen die Gefahr von Sehschäden. Wenn sie den optischen Port überprüfen möchten stellen Sie sicher, dass die Komponente von der Spannungsversorgung getrennt ist.

This section describes how to connect

- a 1000BASE-SX multimode fiber-optic segment from the network or other devices to an LC port connector of a Mini-GBIC (MGBIC-LC01), or
- a 1000BASE-LX single-mode fiber-optic segment from the network or other devices to an LC port connector of a Mini-GBIC (MGBIC-LC09).

Each fiber-optic link consists of two fiber-optic strands within the cable:

- Transmit (TX)
- Receive (RX)

The transmit strand from a switch port connects to the receive port of a fiber-optic Gigabit Ethernet device at the other end of the segment. The receive strand of the applicable LC port connects to the transmit port of the fiber-optic Gigabit Ethernet device.

Enterasys recommends labeling fiber-optic cables to indicate receive and transmit ends. Many cables are pre-labeled, providing matching labels or tapes at both ends of each strand of cable.

To connect an LC cable connector to a fixed LC connector of a Mini-GBIC, refer to [Figure 3-19](#) and proceed as follows:



Caution: Do not touch the ends of the fiber-optic strands, and do not let the ends come in contact with dust, dirt, or other contaminants. Contamination of cable ends causes problems in data transmissions. If the ends of the fiber-optic strands become contaminated, use a canned duster to blow the surfaces clean. A fiber-port cleaning swab saturated with optical-grade isopropyl alcohol may also be used to clean the ends.

Precaución: No toque los extremos de los cables de fibra óptica y evite su contacto con el polvo, la suciedad o con cualquier otro contaminante. Si los extremos de los cables se ensucian, es posible que la transmisión de datos se vea afectada. Si nota que los extremos de los cables de fibra óptica se ensucian, utilice aire comprimido para limpiarlos. También puede limpiarlos con un estropajo embebido en alcohol isopropílico.

1. Remove the protective covers (not shown) from the front panel LC fiber-optic port (port 22 in this example) and from the connectors on each end of the cable.



Note: Leave the protective covers in place when the connectors are not in use to prevent contamination.

2. Insert the LC cable connector into the Mini-GBIC LC connector until it clicks into place.

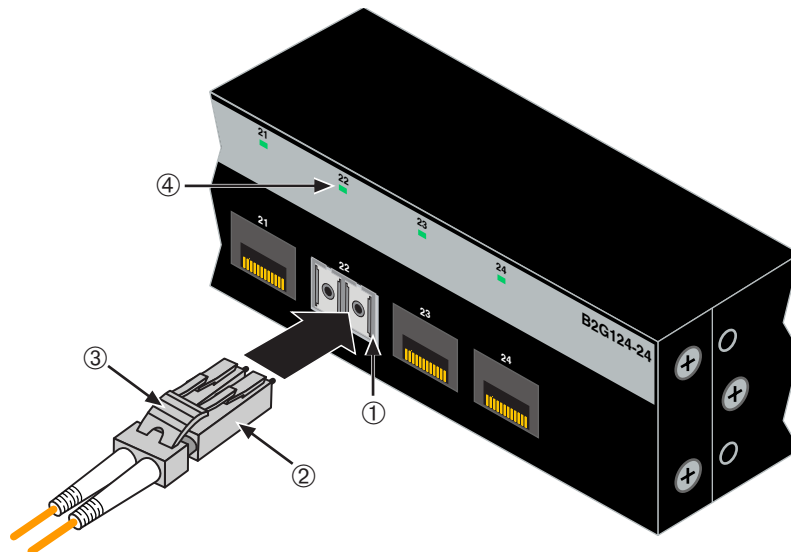

Note: To remove the LC cable connector, press on its release tab and pull it out of Mini-GBIC LC connector.

Figure 3-19 Cable Connection to LC Fiber-Optic Connectors

- | | |
|----------------------------------|---------------------|
| 1 Mini-GBIC MT-RJ port connector | 3 Release tab |
| 2 LC cable connector | 4 Link/Activity LED |

3. Plug the other end of the cable into the appropriate port on the other device. Some cables may be terminated at the other end with two separate connectors, one for each fiber-optic strand. In this case, ensure that the transmit fiber-optic strand is connected to the receive port and the receive fiber-optic strand to the transmit port.
4. Verify that a link exists by checking that the port Link/Activity LED is on (blinking green or solid green). If the Link/Activity LED is off, perform the following steps until it is on:
 - a. Verify that the device at the other end of the segment is ON and connected to the segment.
 - b. If there are separate fiber-optic connections on the other device, check the crossover of the cables. Swap the cable connections if necessary.
 - c. Check that the fiber-optic connection meets the dB loss and cable specifications outlined in the *Cabling Guide* for multimode mode cabling. To obtain this document, refer to [“Related Documents”](#) on page xvi.
 - d. If a link has not been established, refer to [Chapter 4](#) for LED troubleshooting details. If a problem persists, refer to refer to [“Getting Help”](#) on page 1-8 for details on contacting Enterasys Networks for support.
5. Repeat steps 1 through 4, above, until all connections have been made.

Completing the Installation

After installing the switch and making the connections to the network, access the switch management, as described below.

Initial Logon to Switch Management

To initially access switch management from your local PC, terminal, or modem connection, proceed as follows at the displayed startup screen:

1. Enter **rw** (Read-Write) for Username.
2. At the Password prompt, press **Enter** (RETURN).
3. For details on how to configure the switch using the command line interface, refer to the *SecureStack B2 Configuration Guide*. The CLI commands enable you to set a new password and perform more involved management configurations on the switch. One of many capabilities is to reconfigure the stack, reassigning the Manager function to another switch and configuring the order of Member switches that will take over the stack management functions in case the operating Manager is powered down, malfunctions, or is removed from the stack.
4. After the initial configuration, you can also use WebView (Enterasys Networks' embedded web server) for configuration and management tasks.

All the guides associated with the switch are available online at:

<http://www.enterasys.com/support/manuals>

Once you are confident that the installation is successful, route and secure your cables. If you require assistance, contact Enterasys Networks using one of the methods described in “[Getting Help](#)” on page 1-8.

Troubleshooting

This chapter provides information concerning the following:

For information about...	Refer to page...
Using LANVIEW	4-2
Troubleshooting Checklist	4-6
Using the Reset Switch	4-8

This device contains a battery that is not considered a user replaceable part. If the battery needs to be replaced, contact customer service for repair.



Caution: There is a risk of explosion if the battery is replaced with an incorrect type. A used battery may be safely disposed in a municipal waste stream.

Precaucion: Hay riesgo de explosion si la bateria se reemplaza con el typo incorrecto. Puede tirar la bateria usada en la basura.

Using LANVIEW

These switches support the Enterasys Networks built-in LANVIEW LED visual diagnostic and status monitoring system. The LANVIEW LEDs on both the B2G124-24 and B2G124-48 are located in similar locations as shown on B2G124-24 in [Figure 4-1](#). The LANVIEW LEDs on the B2H124-48 are shown in [Figure 4-2](#). These LEDs allow you to quickly observe network status for diagnosing switch and network problems.

Figure 4-1 LANVIEW LEDs of B2G124-24 and B2G124-48 (B2G124-24 shown)

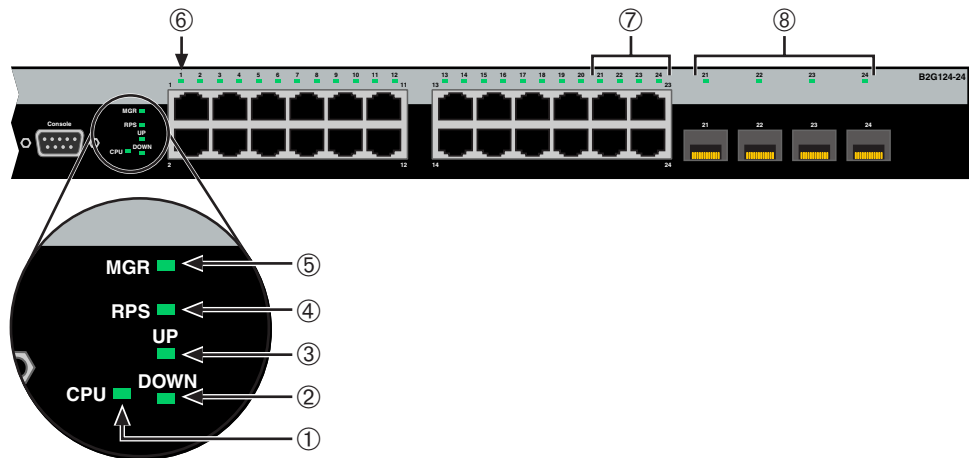

- | | |
|--|--|
| <ul style="list-style-type: none"> 1 CPU LED 2 STACK DOWN LED 3 STACK UP LED 4 RPS LED for redundant power-source status 5 Manager LED 6 Link/Activity LED for <ul style="list-style-type: none"> • B2G124-24/B2G124-48: 10/100/1000 Mbps, RJ45 port 1 | <ul style="list-style-type: none"> 7 Link/Activity LEDs for 10/100/1000 Mbps for <ul style="list-style-type: none"> • B2G124-24: RJ45 ports 21 through 24 • B2G124-48: RJ45 ports 45 through 48 8 Link/Activity LEDs for 1-Gbps Mini-GBIC for <ul style="list-style-type: none"> • B2G124-24: ports 21 through 24¹ • B2G124-48: ports 45 through 48¹ |
|--|--|

1. These Mini-GBIC ports will only establish a link when the RJ45 port equivalent is not linked on a B2G124-24 or B2G124-48. (For example; when Mini-GBIC port 45 is linked, RJ45 port 45 is deactivated. When Mini-GBIC is not linked, the RJ45 port 45 is reactivated and can establish a link as long as the Mini-GBIC port 45 is not linked first.)

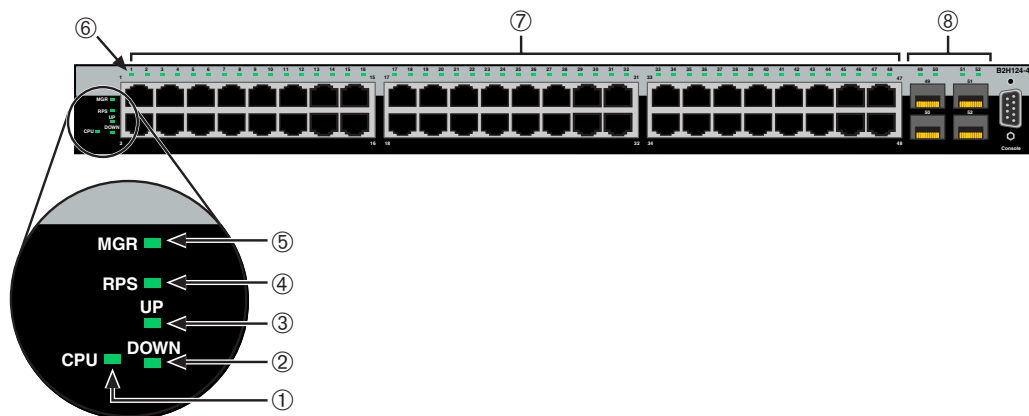
Figure 4-2 LANVIEW LEDs of B2H124-48

- | | |
|---|--|
| 1 CPU LED | 6 Link/Activity LED for 10/100 Mbps, port 1 |
| 2 STACK DOWN LED | 7 Link/Activity LEDs for 10/100 Mbps, RJ45 ports 1 through 48 |
| 3 STACK UP LED | 8 Link/Activity LEDs for 1-Gbps Mini-GBIC ports 49 through 52 ¹ |
| 4 RPS LED for redundant power source status | |
| 5 Manager LED | |

1. Unlike the B2G124-24 or B2G124-48, all 52 ports may be active at the same time.

Table 4-1 describes the LED indications and provides recommended actions as appropriate.



Note: The terms **flashing**, **blinking**, and **solid** used in Table 4-1 indicate the following:

Flashing: LED is flashing randomly.

Blinking: LED is flashing at a steady rate (approximately 50% on, 50% off).

Solid: LED is on steady and not pulsing.

Table 4-1 LANVIEW LEDs

LED	Color	State	Recommended Action
CPU	Off	Power disconnected.	<p>If the LED remains off after connecting AC power or DC power from an RPS, check the following:</p> <ol style="list-style-type: none"> 1. Make sure there is power at the power source (AC source and RPS if applicable). 2. Replace the power cord with a known good one or check the continuity of the power cord. 3. If the switch still does not power up, the system may have a fatal error. Contact Enterasys Networks for technical support.
	Red	Solid. Boot-up failed.	If the LED remains red for several minutes, the system may have a fatal error. Contact Enterasys Networks for technical support.
	Amber	Solid. Diagnostics are running.	If the LED remains amber for more than several minutes, contact Enterasys Networks for technical support.
		Blinking. Code image is being downloaded.	None.
	Green	Solid. System is fully functional.	None.
		Blinking. Boot-up in process.	None.
DOWN	Off	No valid connection to switch stackup connector.	<ol style="list-style-type: none"> 1. Make sure the switch connected to the stackup connector is powered on. 2. Replace cable with a known good one. 3. If the problem still exists, contact Enterasys Networks for technical support.
	Green	Solid. Valid connection to switch stackup connector.	None.
		Blinking. Information is being transferred through the high-speed stacking cable.	

Table 4-1 LANVIEW LEDs (continued)

LED	Color	State	Recommended Action
UP	Off	No valid connection to switch stackdown connector.	<ol style="list-style-type: none"> 1. Make sure the switch connected to the stackdown connector is powered on. 2. Replace cable with a known good one. 3. If the problem still exists, contact Enterasys Networks for technical support.
	Green	<p>Solid. Valid connection to switch stackdown connector.</p> <p>Blinking. Information is being transferred via the high-speed stacking cable.</p>	None.
Manager	Off	Switch is operating as a Member in the stack.	None.
	Green	Solid. Switch is operating as the Manager of the stack.	None.
RPS	Off	RPS not in use.	None.
		Internal power supply failure.	<p>If an RPS is connected to the switch, it should be providing power, perform the following:</p> <ol style="list-style-type: none"> 1. Ensure the RPS is powered on. 2. Ensure that the AC power cord to the RPS is plugged in correctly and that there is power at the AC power source. 3. Replace the power cord with a known good one. 4. Ensure the DC power cord from the RPS to the switch is plugged in correctly. 5. If the problem persists, contact Enterasys Networks for technical support.
	Amber	Solid. The switch internal power supply failed, and the RPS is providing the proper power to the switch.	None.

Table 4-1 LANVIEW LEDs (continued)

LED	Color	State	Recommended Action
Link/ Activity	Off	1. No link.	None.
		2. No activity or port in standby.	None.
		3. If the port is one of the highest numbered last four RJ45 ports, the port is deactivated because the Mini-GBIC port with the same port number is linked.	None.
		4. If the port is a Mini-GBIC port, the port is deactivated because the RJ45 port with the same port number is linked.	None.
Green	Green	Solid. Port is linked, but the interface is not receiving any traffic.	None.
		Blinking. Port is linked and traffic is being received or transmitted by the interface.	None.

Troubleshooting Checklist

If the device is not working properly, refer to [Table 4-2](#) for a checklist of problems, possible causes, and recommended actions to resolve the problem.

Table 4-2 Troubleshooting Checklist

Problem	Possible Cause	Recommended Action
All LEDs are OFF.	Loss of power.	Ensure that the switch was installed properly according to the installation instructions in Chapter 3 .
		Ensure that the power cords are connected properly to an active power source that meets the AC input specifications for this switch.
		Ensure that the AC power cord is not damaged. Replace the power cord with a known good one.
No local management startup screen.	Incorrect terminal setup.	Refer to the <i>SecureStack B2 Configuration Guide</i> for proper setup procedures.
	Improper Console cable pinouts.	Refer to Appendix A for proper Console port pinouts.
	Corrupt firmware image, or hardware fault.	If possible, attempt to download the image to the device again. Refer to the <i>SecureStack B2 Configuration Guide</i> for details.

Table 4-2 Troubleshooting Checklist (continued)

Problem	Possible Cause	Recommended Action
Cannot navigate beyond startup screen.	Improper Community Names Table.	Refer to the <i>SecureStack B2 Configuration Guide</i> for the Community Names Table setup.
Cannot contact the switch through in-band management.	IP address not assigned.	Refer to the <i>SecureStack B2 Configuration Guide</i> for the IP address assignment procedure.
	Port is disabled.	This is normal if the switch is a Member in a stack. If operating as a standalone switch or as the Manager in a stack, enable the port. Refer to the <i>SecureStack B2 Configuration Guide</i> for instructions to enable/disable ports.
	No link to switch.	Verify that all network connections between the network management station and the device are valid and operating. If the problem continues, contact Enterasys Networks for technical support.
Port(s) goes into standby for no apparent reason.	Loop condition detected.	Verify that Spanning Tree is enabled. Refer to the <i>SecureStack B2 Configuration Guide</i> for the instructions to set the type of STA. Review the network design and delete unnecessary loops. If the problem continues, contact Enterasys Networks for technical support.
User parameters (IP address, switch and module name, etc.) were lost when the switch power was cycled.	Clear NVRAM was set using CLI commands.	Reenter the lost parameters as necessary. Refer to the <i>SecureStack B2 Configuration Guide</i> for the instructions to configure the switch using CLI commands. If the problem continues, contact Enterasys Networks for technical support.

Using the Reset Switch

If you forget the switch login password, use the Reset switch as described in the following procedure.

Figure 4-3 Reset Switch

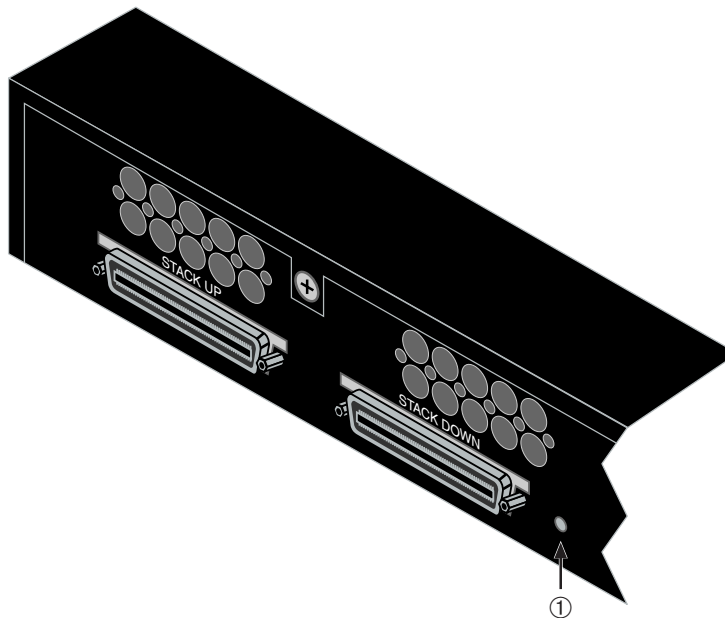

1 Reset switch

To reset the switch password, refer to [Figure 4-3](#) and proceed as follows:



Note: Notify the system manager before changing the password.

1. Press-and-hold the Reset switch while the switch is operational. This change of the login password to the default password will be indicated via CLI only.
2. Logon to switch management. You can now logon to the switch via the Console port and assign a new password using the command line interface (CLI).
3. To access switch management from your local PC, terminal, or modem connection, refer to the *SecureStack B2 Configuration Guide* for instructions on how to log in and enter a new password. The guide is available online under the C category at:

<http://www.enterasys.com/support/manuals>

If you require assistance, contact Enterasys Networks using one of the methods described in “[Getting Help](#)” on page 1-8.



Specifications

This appendix provides information about the following:

For information about...	Refer to page...
Switch Specifications	A-1
Mini-GBIC Input/Output Specifications	A-4
Gigabit Ethernet Specifications	A-4
MGBIC-02 Specifications (1000BASE-T)	A-7
Regulatory Compliance	A-8

Enterasys Networks reserves the right to change the specifications at any time without notice.

Switch Specifications

[Table A-1](#) provides the I/O ports, processors and memory, physical, and environmental specifications for the B2G124-24, B2G124-48, and B2H124-48.

Table A-1 Switch Specifications

Item	Specification
B2G124-24	
RJ45 ports 1 through 24	Twenty-four, 10BASE-T/100BASE-TX /1000BASE-T compliant ports with auto-sensing and auto-negotiation via RJ45 UTP connectors.
SFP ports 21 through 24	Four slots that support optional Mini-GBICs 1000BASE-FX fiber-optic connections and 1000BASE-T copper connections. When an SFP transceiver (Mini-GBIC) is installed in ports 21 through 24 and establishes a link, the associated RJ45 fixed front panel 10BASE-T/100BASE-TX/1000BASE-T port is disabled.

Table A-1 Switch Specifications (continued)

Item	Specification
B2G124-48	
RJ45 ports 1 through 48	Forty-eight, 10BASE-T/100BASE-TX/1000BASE-T compliant ports with auto-sensing and auto-negotiation through the RJ45 connections.
SFP ports 45 through 48	Four slots that support optional Mini-GBICs for 1000BASE-FX fiber-optic connections and 1000BASE-T copper connections. When an SFP transceiver (Mini-GBIC) is installed in ports 45 through 48 and establishes a link, the associated fixed front panel RJ45 10BASE-T/100BASE-TX /1000BASE-T port is disabled.
B2H124-48	
RJ45 ports 1 through 48	Forty-eight, 10BASE-T/100BASE-TX compliant ports with auto-sensing and auto-negotiation via RJ45 connectors.
SFP ports 49 through 52	Four slots that support optional Mini-GBICs for 1000BASE-T Gigabit copper and 1000BASE-FX fiber-optic connections. Unlike the B2G124-24 and B2G124-48, all ports may be linked and operating without affecting any RJ45 ports.
Processors/Memory	
Processor	MPC8245, 400 MHz processor
Dynamic Random Access Memory (DRAM)	256 MB
FLASH Memory	32 MB
Physical	
Dimensions	4.4 H x 44.1 W x 36.85 D (cm) 1.7 H x 17.4 W x 14.5 D (in.)
Approximate Weight	
B2G124-24	Gross: 6.30 kg (13.9 lb) (shipping carton containing one module) Net: 5.05 kg (11.1 lb) (one module without packaging)
B2G124-48	Gross: 6.96 kg (15.3 lb) (shipping carton containing one module) Net: 5.71 kg (12.6 lb) (one module without packaging)
B2H124-48	Gross: 6.52 kg (14.3 lb) (shipping carton containing one module) Net: 5.27 kg (11.6 lb) (one module without packaging)

Table A-1 Switch Specifications (continued)

Item	Specification
Predicted hours for Mean Time Between Failures (MTBF)	For the MTBF hours for these products, refer to the MTBF web site at URL http://www.enterasys.com/support/mtbf/
Heat Dissipation (maximum)	
B2G124-24	@ 86.40 W, 294.80 Btu/hr
B2G124-48	@ 129.50 W, 441.87 Btu/hr
B2H124-48	@ 65.50 W, 205.80 Btu/hr
AC Input Specifications	
Input Voltage	100 to 240 VAC
Input Current	
B2G124-24	0.8 A Max
B2G124-48	1.4 A Max
B2H124-48	0.8 A Max
Frequency	50 to 60 Hz
Environmental	
Operating Temperature	5°C to 40°C (41°F to 104°F)
Storage Temperature	-40°C to 70°C (-40°F to 158°F)
Operating Relative Humidity	5% to 90% (non-condensing)

Mini-GBIC Input/Output Specifications

The Mini-Gigabit Ethernet Card (Mini-GBIC) port interface slots can support 1-Gbps fiber-optic connections as described in [Table A-2](#). The optional Mini-GBICs are hot swappable.

Table A-2 Mini-GBIC Input/Output Port Specifications

Item	Specification
MGBIC-LC01	Provides one LC fiber-optic multimode port that is compliant with the 1000BASE-SX standard LC connector.
MGBIC-LC03	Provides one LC fiber-optic multimode port that is compliant with the 1000BASE-SX standard LC duplex style connector.
MGBIC-LC09	Provides one LC fiber-optic single-mode port that is compliant with the 1000BASE-LX standard LC connector.
MGBIC-MT01	Provides one MT-RJ fiber-optic multimode port that is compliant with the 1000BASE-SX standard MT-RJ connector.
MGBIC-08	Provides one LC fiber-optic single-mode port that is compliant with the 1000BASE-ELX standard LC connector.
MGBIC-02	Provides one RJ45 copper connection that is compliant with the 1000BASE-T standard RJ45 connector.

Gigabit Ethernet Specifications

The following specifications for the Mini-GBICs shown in [Table A-3](#) through [Table A-10](#) meet or exceed the IEEE 802.3z-1998 standard.

MGBIC-LC01/MGBIC-MT01 Specifications (1000BASE-SX)

Table A-3 MGBIC-LC01/MGBIC-MT01 Optical Specifications

Item	62.5 μ m MMF	50 μ m MMF
Transmit Power (minimum)	-9.5 dBm	-9.5 dBm
Receive Sensitivity	-17 dBm	-17 dBm
Link Power Budget	7.5 dBm	7.5 dBm

Table A-4 MGBIC-LC01/MGBIC-MT01 Operating Range

Item	Modal Bandwidth @ 850 nm	Range
62.5 µm MMF	160 MHz/km	2-220 Meters
62.5 µm MMF	200 MHz/km	2-275 Meters
50 µm MMF	400 MHz/km	2-500 Meters
50 µm MMF	500 MHz/km	2-550 Meters

MGBIC-LC03 Specifications (1000BASE-SX)

Table A-5 MGBIC-LC03 Optical Specifications

Item	62.5/125 µm MMF	50/125 µm MMF
Transmit Power (minimum)	-9.5 dBm	-9.5 dBm
Transmit Power (maximum)	-3 dBm	-3 dBm
Receive Sensitivity	-20 dBm	-20 dBm
Link Power Budget ¹ (Multimode Only)	10.5 dBm	10.5 dBm

1. The maximum drive distance (up to 2 km) depends on the quality of the installed multimode fiber-optic cable segment. Use the Link Power Budget to calculate the maximum cable length of the attached segment. The Link Power Budget must not exceed those specified in this table. The MGBIC-LC03 input power must not exceed -3 dBm. Otherwise, saturation could occur.

Table A-6 MGBIC-LC03 Operating Range

Item	Modal Bandwidth @ 1310 nm	Range
62.5 µm MMF	160 MHz/km	2,000 Meters
50 µm MMF	400 MHz/km	2,000 Meters

MGBIC-LC09 Specifications (1000BASE-LX)

Table A-7 MGBIC-LC09 Optical Specifications

Item	62.5 μ m MMF	50 μ m MMF	10 μ m SMF
Transmit Power (minimum)	-11.5 dBm	-11.5 dBm	-9.5 dBm
Receive Sensitivity	-20 dBm	-20 dBm	-20 dBm
Link Power Budget	8.5 dBm	8.5 dBm	10.5 dBm

Table A-8 MGBIC-LC09 Operating Range

Item	Modal Bandwidth @ 1300 nm	Range
62.5 μ m MMF	500 MHz/km	2-550 Meters
50 μ m MMF	400 MHz/km	2-550 Meters
50 μ m MMF	500 MHz/km	2-550 Meters
10 μ m SMF	N/A	2-10,000 Meters

MGBIC-08 Specifications (1000BASE-ELX)

Table A-9 MGBIC-08 Optical Specifications

Item			
Transmit Power (minimum)	-0 dBm, min.	+2 dBm, typical	+5 dBm, max.
Receive Sensitivity	-24 dBm, min.	-26 dBm, typical	
Maximum Input Power	-3 dBm		
Link Power Budget ¹ (Full Duplex Only)	23 dB	28 dB, typical	

1. The maximum drive distance (up to 70 km) depends on the quality of the installed single-mode fiber-optic cable segment. Use the Link Power Budget to calculate the maximum cable length of the attached segment. The Link Power Budget must not exceed those specified in this table. The MGBIC-08 input power must not exceed -3 dBm. Otherwise, saturation could occur.

Table A-10 MGBIC-08 Operating Range

Item	1550 nm	Range
9 or 10 μ m SMF	N/A	70,000 Meters

MGBIC-02 Specifications (1000BASE-T)

Table A-11 MGBIC-02 Specifications

Item	Specification
Supported Cable:	
Type	Copper, Category 5 UTP
Maximum Length	Up to 100 meters
Connector	RJ45
Data Rate	1 Gbps, IEEE 802.3:2000 compatible 1000BASE-T operation only Automatic crossover detection
TX Output impedance	100 ohms, typical at all frequencies between 1 MHz and 125 MHz
RX Input impedance	100 ohms, typical at all frequencies between 1 MHz and 125 MHz

Console Port Pinout Assignments

The Console port is a DB9 serial communications port for local access to Local Management. Refer to [Figure A-1](#) for the Console port pin assignments.

Figure A-1 Console Port Pinout Assignments

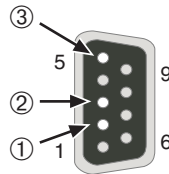

- | | |
|---|---|
| <p>1 Pin 2, Received Data (input)</p> <p>2 Pin 3, Transmitted Data (output)</p> | <p>3 Pin 5, Signal Ground</p> <p>All other pins not connected.</p> |
|---|---|

Regulatory Compliance

The B2G124-24, B2G124-48, and B2H124-48 meet the safety and electromagnetic compatibility (EMC) requirements listed in [Table A-12](#):

Table A-12 Compliance Standards

Regulatory Compliance	Standards
Safety	UL 60950, CSA C22.2 No. 60950, 73/23/EEC, EN 60950, and IEC 60950. The Mini-GBICs that support laser connections also meet the EN 60825 and 21 CFR 1040.10 standards.
Electromagnetic Compatibility (EMC)	47 CFR Parts 2 and 15, CSA C108.8, 89/336/EEC, EN 55022, EN 61000-3-2, EN 61000-3-3, EN 55024, AS/NZS CISPR 22, and VCCI V-3.

Numerics

- 1000BASE-SX/LX network connections
 - requirements for [2-2](#)
- 1000BASE-T
 - requirements for [2-2](#)
- 100BASE-TX
 - requirements [2-2](#)
- 10BASE-T
 - connection [3-22](#)
 - requirements [2-1](#)

A

- AC input specifications [A-3](#)

B

- B2G124-24
 - overview of [1-2](#)
- B2G124-48
 - overview of [1-2](#)
- B2H124-48
 - overview of [1-4](#)

C

- Cable
 - Fiber Budget [A-3](#)
- Cable specifications
 - 1000BASE-SX/LX network [2-2](#)
 - 1000BASE-T network [2-2](#)
 - 100BASE-TX network [2-2](#)
 - 10BASE-T network [2-1](#)
- CLI command
 - introduction to [1-7](#)
- Configuring switches
 - stack configuration [3-12](#)
- Connecting to the network [3-22](#)
- Connectivity
 - introduction to [1-5](#)
- Console port
 - pinout assignments [A-7](#)

D

- Document conventions [xvii](#)

E

- Electromagnetic Compatibility (EMC)
 - requirements [A-8](#)
- Enterasys
 - contacting [1-8](#)

F

- Fiber budget [A-3](#)
- Front panel [1-3](#), [1-4](#)

H

- High-Speed Stack Connections
 - introduction to [1-5](#)
- High-speed stacking cables
 - installation of [3-10](#)

I

- Installation
 - connecting to the network [3-22](#)
 - high-speed stacking cables [3-10](#)
 - in a rack [3-9](#)
 - new stack [3-14](#)
 - new switch in existing stack [3-15](#)
 - optional Mini-GBIC [3-3](#)
- Installation site
 - what is needed at the [3-8](#)

L

- LANVIEW Diagnostic LEDs
 - introduction to [1-7](#)
- LANVIEW LEDs [4-2](#)
- Link LEDs
 - viewing of [4-2](#), [4-3](#)
- Local Management
 - introduction to [1-7](#)

M

- Management
 - use of [1-7](#)
- MGBIC-08
 - specifications for [A-6](#)
- MGBIC-LC01
 - specifications for [A-4](#), [A-5](#)
- MGBIC-LC03
 - specifications for [A-5](#)
- MGBIC-LC09
 - specifications for [A-5](#)
- MGBIC-MT01
 - specifications for [A-4](#), [A-5](#)
- Mini-GBIC
 - installation of [3-3](#)
 - removal of [3-5](#)
- Mini-GBIC input/outputs
 - specifications for [A-3](#)

- P**
- Pinout assignments
 - console port [A-7](#)
 - UTP 4-wire crossover cable [3-24](#)
 - UTP 4-wire straight-through cable [3-24](#)
 - UTP 8-wire crossover cable [3-25](#)
 - UTP 8-wire straight-through cable [3-25](#)
 - Power connection
 - AC [3-15](#)
 - RPS DC [3-17](#)
 - Processors/memory [A-2](#)
- R**
- Rackmount installation
 - guidelines for [3-9](#)
 - Receive/Transmit LEDs
 - viewing of [4-2](#), [4-3](#)
 - Redundant Power Supply Capability
 - introduction to [1-5](#)
 - Regulatory Compliance [A-8](#)
 - Related manuals [xvi](#)
 - Reset switch [4-8](#)
- S**
- Safety requirements [A-8](#)
 - Specifications [A-1](#)
 - B2G124-24 [A-1](#)
 - B2G124-48 [A-2](#)
 - B2H124-48 [A-2](#)
 - MGBIC-08 [A-6](#)
 - MGBIC-LC01 [A-4](#), [A-5](#)
 - MGBIC-LC03 [A-5](#)
 - MGBIC-LC09 [A-5](#)
 - MGBIC-MT01 [A-4](#), [A-5](#)
 - Mini-GBIC input/outputs [A-3](#)
 - Stack initialization
 - Manager switch selection [3-17](#)
 - Stack Manager
 - automatic selection of [3-17](#)
 - Stack Member
 - automatic selection of [3-17](#)
 - Stack operation
 - Member switch selection [3-17](#)
 - Stack System
 - installation of a new switch in existing stack [3-15](#)
 - installation of new [3-14](#)
 - Standalone Switches
 - specifications for [A-1](#)
 - Standards compatibility [1-7](#)
 - Switch
 - overview of [1-2](#)
 - Switch carton
 - contents of [3-2](#)
 - unpacking of [3-2](#)
 - Switch Operation
 - stack installation [3-12](#)
- T**
- Troubleshooting [4-2](#)
 - checklist [4-6](#)
- U**
- Unpacking the module [3-2](#)
- V**
- Viewing Receive and Transmit Activity
 - instructions for [4-2](#), [4-3](#)
- W**
- WebView
 - introduction to [1-7](#)